VISTA SERIES

PARTITIONED SECURITY SYSTEM

**4140XMPT
INSTALLATION
INSTRUCTIONS**

ADEMCO

CONGRATULATIONS on your purchase of the VISTA 4140XMPT!

The purpose of these Installation Instructions is to give you a brief overview of the VISTA 4140XMPT system, and provide instructions for installing a basic system.

As always, ADEMCO is there for YOU! Our SALES and TECHNICAL SUPPORT staff are eager to assist you in any way they can, so don't hesitate to call, for any reason!

East Coast Technical Support: 1-800-645-7492 (8 a.m.-6 p.m. E.S.T.)
West Coast Technical Support: 1-800-458-9469 (8 a.m.-5 p.m. P.S.T.)

PLEASE,

Before you call Technical Support, be sure you have:

- Checked all wiring connections.
- Determined that the power supply and/or backup battery are supplying proper voltages.
- Verified your programming information where applicable.
- Noted the proper model number of this product, and the version level (if known) along with any documentation that came with the product.
- Noted your Ademco customer number and/or company name.

Having this information handy will make it easier for us to serve you quickly and effectively.

Again, CONGRATULATIONS, and WELCOME ABOARD!

TABLE OF CONTENTS

<p>I. GENERAL INFORMATION..... 5</p> <p>INTRODUCTION TO THE CONTROL..... 5</p> <p>SUMMARY OF 4140XMPT SYSTEM FEATURES..... 5</p> <p>INTRODUCTION TO PARTITIONED SYSTEMS..... 6</p> <p> Basic Partitioning Features..... 6</p> <p> Examples of Partitioning..... 6</p> <p> Global Partitioning Features & Resources..... 6</p> <p> Partition Specific Features..... 6</p> <p>II. ZONE CONFIGURATIONS..... 7</p> <p>ZONE TYPE DEFINITIONS..... 7</p> <p>BASIC 9 HARD-WIRED ZONES..... 7</p> <p> Zone 1..... 7</p> <p> Zone 9..... 7</p> <p> Zones 2-8..... 7</p> <p>2-WIRE POLLING LOOP (Multiplex Loop)..... 8</p> <p> Advisories..... 8</p> <p> Polling Loop Devices..... 8</p> <p>WIRELESS EXPANSION..... 9</p> <p> 4280/4280-S RF Receivers..... 9</p> <p> Programming Notes for Wireless Devices..... 9</p> <p> Supervision..... 9</p> <p> House Identification..... 9</p> <p> Transmitter Identification..... 9</p> <p> Sniffer Mode to Determine House ID..... 9</p> <p> Checking Transmitter House IDs..... 9</p> <p> Go/No Go Test Mode..... 9</p> <p> Important Battery Notice..... 10</p> <p> Fault Annunciation..... 10</p> <p> Wireless Zone Types..... 10</p> <p> Advisories..... 10</p> <p> Wireless Devices..... 10</p> <p>III. PERIPHERAL DEVICES..... 11</p> <p>REMOTE CONSOLES..... 11</p> <p> 5137AD Addressable Alpha LCD Console..... 11</p> <p> Programming the Consoles..... 11</p> <p> Wiring Consoles..... 11</p> <p> Surface Mounting the Consoles..... 11</p> <p> Addressable Console DIP Switches..... 11</p> <p> Powering Additional Consoles..... 12</p> <p> Flush Mounting with Trim Ring Kit (5137TRK)..... 12</p> <p> Adjusting the Alpha Console Viewing Angle..... 12</p> <p>EXTERNAL SOUNDERS..... 13</p> <p> Relay Output..... 13</p> <p> Non-UL Installations..... 13</p> <p> UL Installations..... 13</p> <p> Compatible Sounders..... 13</p> <p>SMOKE DETECTORS..... 13</p> <p> Zone 1..... 13</p> <p> Zones 2-8..... 13</p> <p> Compatible Smoke Detectors..... 13</p> <p> Polling Loop Smoke Detectors..... 13</p> <p> Wireless Smoke Detector..... 13</p> <p>PASSIVE INFRARED DETECTORS..... 13</p> <p>GLASS BREAK DETECTORS..... 14</p> <p>PHONE LINE CONNECTIONS..... 14</p> <p>CONNECTOR J7 TRIGGER OUTPUTS..... 14</p> <p> General Information..... 14</p> <p> Ground Start Module..... 14</p> <p> Remote Keyswitch (4146)..... 15</p> <p> Remote Console Sounder Operation..... 15</p> <p>CONNECTOR J8 INPUTS & OUTPUTS..... 16</p> <p> Event Logging Printer Connections..... 16</p> <p> Direct Wire Downloading Connections..... 16</p> <p>IV. MOUNTING & POWERING..... 17</p> <p>MOUNTING..... 17</p> <p> Mounting the 4140XMPT PC Board..... 17</p> <p> Mounting the Cabinet Lock..... 17</p> <p>POWERING THE SYSTEM..... 18</p> <p> Primary Power..... 18</p> <p> Back-Up Power..... 18</p> <p> Battery Standby Table..... 18</p> <p> Earth Ground Connections..... 18</p> <p> Power-Up Procedure..... 18</p> <p> Polling Loop Current Draw Worksheet..... 18</p> <p> Auxiliary Device Current Draw Worksheet..... 18</p>	<p>V. SYSTEM OPERATION..... 19</p> <p>SECURITY ACCESS CODES..... 19</p> <p> User Codes & Levels of Authority..... 19</p> <p> Multiple Partition Access (GOTO Function)..... 19</p> <p> Installer Code..... 20</p> <p> Master/Manager Codes..... 21</p> <p> Operator Codes..... 21</p> <p> Duress Code..... 21</p> <p>SETTING THE REAL-TIME CLOCK..... 21</p> <p>KEYPAD FUNCTIONS..... 22</p> <p> Arming Functions..... 22</p> <p> Partition "GOTO" Commands..... 22</p> <p> View Capabilities of a User..... 22</p> <p> Viewing Downloaded Messages..... 22</p> <p> Using the Built-in User's Guide..... 22</p> <p> Displaying Descriptors..... 22</p> <p> Panic Keys..... 22</p> <p>TROUBLE CONDITIONS..... 23</p> <p> "Check" Message..... 23</p> <p> Power Failure..... 23</p> <p> Other Trouble Conditions..... 23</p> <p>EVENT LOGGING PROCEDURES..... 23</p> <p> Programming..... 23</p> <p> Display & Print Modes..... 24</p> <p> Clear Event Log..... 24</p> <p>VI. SYSTEM COMMUNICATIONS..... 25</p> <p>Split/Dual Reporting..... 25</p> <p>Ademco Low Speed..... 25</p> <p>SESCOA/Radionics..... 25</p> <p>4+2 Reporting..... 25</p> <p>4+2 Express..... 25</p> <p>Ademco High Speed Reporting..... 25</p> <p>Contact ID Reporting..... 25</p> <p>Table of Contact ID Event Codes..... 26</p> <p>Communication Programming Guide..... 26</p> <p>VII. PROGRAMMING THE SYSTEM..... 27</p> <p>GENERAL PROGRAMMING PROCEDURES..... 27</p> <p> Communication Default Programming..... 27</p> <p> User Friendly Zone, Device & Alpha Programming..... 27</p> <p> Programming Steps..... 27</p> <p>COMMUNICATION PROGRAMMING..... 28</p> <p> Loading Defaults..... 28</p> <p> Easy-to-Program Communication Fields..... 28</p> <p> Enabling of Dialer Reporting by Partition..... 28</p> <p>PROGRAMMING DATA FIELDS..... 29</p> <p> Global Programming Fields..... 29</p> <p> Partition Programming..... 29</p> <p>993 MENU MODE..... 30</p> <p> Zone Programming..... 30</p> <p> Device Programming..... 30</p> <p> Alpha Programming..... 31</p> <p> Entering Zone Descriptors..... 31</p> <p> Adding Custom Words..... 31</p> <p> Creating Partition Descriptors..... 31</p> <p> Creating a Custom Message..... 32</p> <p> Vocabulary of Words in Memory..... 32</p> <p>VIII. DOWNLOADING PRIMER..... 33</p> <p>IX. TESTING THE SYSTEM..... 34</p> <p>Using Test Mode..... 34</p> <p>Armed System Test..... 34</p> <p>Turning the System Over to the User..... 34</p> <p>UL INSTALLATION REQUIREMENTS..... 34</p> <p>X. TROUBLESHOOTING..... 35</p> <p>CONSOLES..... 35</p> <p>HARD-WIRED ZONES 1-9..... 35</p> <p>RPMs..... 35</p> <p>WIRELESS..... 35</p> <p>COMMUNICATIONS..... 37</p> <p>XI. SPECIFICATIONS..... 38</p> <p>XII. 4190WH OPERATION & WIRING..... 38</p> <p> DIP SWITCH SETTING TABLES..... 40</p> <p> PROGRAMMING FORM..... 43</p> <p> INDEX TO PROGRAM FIELDS..... 47</p>
---	--

LIST OF FIGURES

1.	PARTITIONED SYSTEM.....	5
2.	ADDRESSABLE CONSOLE WITH DIP SWITCH.....	11
3.	SURFACE MOUNTING THE CONSOLES	11
4.	POWERING ADDITIONAL CONSOLES	12
5.	FLUSH MOUNTING THE CONSOLES	12
6.	ADJUSTING THE VIEW ANGLE/INSERTING THE NAMEPLATE.....	12
7.	CONNECTOR J7.....	14
8.	GROUND START MODULE	14
9.	REMOTE KEYSWITCH WIRING.....	15
10.	REMOTE CONSOLE SOUNDING DIAGRAM	15
11.	EVENT LOGGING PRINTER CONNECTIONS	16
12.	DIRECT WIRE DOWNLOADING CONNECTIONS.....	16
13.	MOUNTING THE PC BOARD.....	17
14.	MOUNTING THE CABINET LOCK.....	17
15.	4190WH OPERATION & WIRING DIAGRAM.....	38
16.	SUMMARY OF CONNECTIONS DIAGRAM.....	39

I. GENERAL INFORMATION

INTRODUCTION TO THE CONTROL

NOTE: At least one 5137AD console must be used with this system.

The VISTA 4140XMPT Control is a microprocessor based, programmable, partitioned system, and features EEROM memory technology (power loss does not result in the loss of information). The Control supports up to 9 wired zones of protection, expandable to 64 zones (wired and/or wireless) using 2-wire polling loop devices, and/or wireless transmitters (5700 series), and supports alpha (5137AD) display consoles. Before installing this partitioned system, become completely familiar with the partitioning concepts, including zone distribution (each zone can be assigned to only one partition), user code usage and authority levels, and the friendly alpha console programming for zones and descriptors.

Programming can be performed at the office prior to installation, or on the job site directly from the console, or can be downloaded from a remote location or at the job site (using a PC/laptop with 4100SM Serial Module) by using the Ademco 4130PC Downloading Software. For installer convenience, the Control is pre-programmed with a set of standard values that is designed to meet the needs of many installations. These values, however, can be changed to suit the needs of any particular installation. The Control can also be pre-programmed by the installer with one of four standard communication default programming values, thus further saving time and effort.

SUMMARY OF 4140XMPT SYSTEM FEATURES

SYSTEM IN GENERAL

- Up to 8 logical partitions of operation, and supports up to sixteen 5137AD consoles.
- Built-in Polling Loop interface, with polling loop terminals located on the panel's terminal block, allows expansion up to 64 zones.
- Supports up to 50 latching type 2-wire glass break detectors on zone 8.
- Supports up to 16 2-wire smoke detectors on zone 1.
- Quick (forced) bypass feature bypasses all faulted zones with single key entry sequence (Code + BYPASS + #).
- Memory-of-alarm feature, which, upon disarming the system, automatically displays all zones that were in an alarm condition while the system was armed.
- Self resetting circuit breaker protection eliminates the need to replace blown cartridge fuses.
- Built-in Users Manual (5137AD only). By depressing and holding any of the function keys on the console for 5 seconds, a brief explanation of that particular function scrolls across the alpha-numeric display.
- All programmed descriptors can be displayed (one at a time) by pressing and holding the READY key for 5 seconds, then releasing the key. This serves as a check for installers to be sure all descriptors are entered properly.
- Large cabinet with removable door for easier installations.

PROGRAMMING

- Up to 128 user security codes (max. 99 per partition) can be programmed, each with various levels of authority.
- Installer code override feature. Installer code will disarm system only if it was used to arm the system.
- All zones and partitions can be assigned alpha descriptions.
- Up to 20 custom words can be added to the built-in vocabulary.
- The letter "s" or "s" can be added to descriptors.
- Easy programming for communication fields. Simply enter the desired code for each zone.
- Communication default programming can be loaded anytime, and does not affect non-communication program fields.
- Direct wire downloading can be done without a modem, using a PC or Laptop computer and 4100SM Serial Module.
- Easy programming of zones using #93 Menu Mode.

COMMUNICATION

- All 64 zones can report to a central station using any reporting format.
- Callback defeat option for downloading.
- Real-Time clock included for time related functions. NOTE: 5137AD console must be used to set the real-time clock, or can be set using Downloader software.
- Random AC Loss and AC Restore reporting option sends report randomly from 10-40 minutes after AC loss, to help prevent central stations from receiving an overload of reports due to area blackouts.
- Intelligent test reporting option means test reports will not be sent if any other report was sent within the programmed test report interval.
- Split/Dual reporting communicator option.
- Option to allow a cancel report to be sent, even after Bell Time-out has ended.
- PC Downloader ability to command output voltage trigger to pulse on for 2 seconds.

Partitioning Architecture

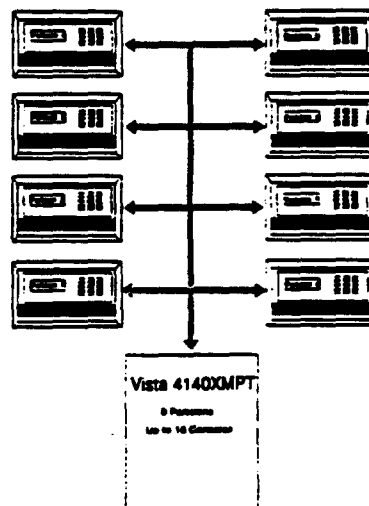

INTRODUCTION TO THE PARTITIONED SYSTEM

This section is intended to give you, the installer, an overview of the 4140XMPT partitioning concepts. For specific questions on programming or using specific aspects of the panel, please refer to the **SYSTEM OPERATION** and **PROGRAMMING THE SYSTEM** sections of this manual.

The 4140XMPT represents the latest in space protection technology. Combining wired, wireless and polling loop zones into one powerful control, the 4140XMPT is a control communicator capable of supporting a true "partitioned" environment. A partitioned environment is one whereby multiple unrelated users wish to be protected by a security system yet each user requires the operational freedom to have the system behave as if it was theirs and theirs alone. This global definition implies a lot of things in terms of the required features of the equipment you will install. Some basic features are listed below:

BASIC PARTITIONING FEATURES

- Easy to use and program as the simplest alarm system.
- Integrity of security is not compromised for any user's of the system.
- Inherent reliability of the partitioned system is equal to a stand alone alarm system if purchased separately.
- Flexible number of consoles per partition (Up to 16 anyway you want to assign them!)
- 128 User Codes assigned virtually anyway you want them (99 max per any partition, otherwise no restrictions) Enough to handle the largest commercial jobs.
- 64 zones employing wired, wireless or multiplex technology (Install any mix for any type of construction challenges!)
- Appropriate sounds and messages to assigned consoles only (Each system appears to be independent to users)
- Ability to inhibit other consoles from using your partition (Total security in a strip mall environment)
- "GOTO" function provides access to other partitions (Ideal for executive access to factory for example)
- Multiple levels of authority per partition (Allows key people in a partition to have complete control and limit system tampering by others)
- Any zone can be assigned to any particular partition (Easy to install, allows logical assignment by the dealer)
- Intelligent partition/zone programming help (Simplifies the programming and reduces errors)
- Programmable 4-character Partition name displayed when needed (No need to memorize numbers - name and number are shown for you)

EXAMPLES OF PARTITIONING

In surveying dealers throughout the country, we have learned of two global applications for partitioned control panels. One is a typical two family house (residential), the other a Factory/Office environment (commercial). These broad classifications can better be understood by way of examples.

TWO FAMILY HOUSE: You've just arrived at a job site to quote a security system. The owner wants an alarm system which he can use for his family (living upstairs) AND he also wants to provide protection for the separate living quarters of his mother (living downstairs with separate entrance). The owner obviously wants to keep costs down yet provide protection and flexibility for his mother living downstairs. You could choose to install a traditional alarm panel to keep costs down, but the system would be very limiting for either the mother or the upstairs family. To meet the flexibility requirements as desired, you could install two traditional alarm panels, but the cost might cause you to lose the business. Now you can quote the 4140XMPT with confidence!

FACTORY/OFFICE: You arrive at a small manufacturing concern looking to provide protection throughout their offices as well as their factory. The very nature of the business is such that factory workers come to work at 7:30AM and leave at 4PM, while the offices are open 8:30AM to 6:00PM. Some executives even want to stay late at night or come back to work after 6:00PM. Installing two panels (one for the factory, one for the offices) would certainly work at a cost premium, but think of all the complexity when owners tried to gain access to the factory after hours...two access codes to remember, accidental false alarms. Even the real frustration of not being able to properly program the two systems to allow easy access from the factory to office or vice versa! Install the 4140XMPT, your programming problems are over, and the owners of the business will appreciate its flexibility and ease of use!

GLOBAL PARTITIONING FEATURES AND RESOURCES

In any system, certain physical system components and features are shared by all partitions or assigned to a specific partition. In the 4140XMPT, the following elements are shared or assignable to a specific partition:

Dialer	shared by all partitions
Alarm Relay/Sounder	shared by all partitions
Power Supply	shared by all partitions
Wireless Keypad	assignable to one partition
Keyswitch Station	assignable to one partition

In addition to the physical devices which are shared, the system shares some software features on a global basis as well. These include:

Panic Code Reports	Common code for any partition
Low Battery Reporting	Reports as Partition 1
AC Power Reporting Options	Reports as Partition 1
Test Reporting Interval	Global for the Panel
Download Phone Number	Global for the Panel
Communication Format	Global for the Panel
Rotary/Touch Tone	Global for the Panel
Download Callback defeat	Global for the Panel
Installer Code	Global for all Partitions

PARTITION SPECIFIC FEATURES

Many devices and functions need to be reserved on a partition basis to provide proper operation and flexibility for installations.

The items assignable on a per partition basis include:

• Consoles	• Enable/Disable chime Mode
• Entry and Exit Delays	• "Go To" Partition function
• Console Sound during Exit Delay	• Swinger Suppression
• Primary Subscriber Number	• Burglary Alarm Comm. Delay
• Secondary Subscriber Number	• Open/close for Installer Code
• Enable/Disable of Panic Keys	• Confirmation of Arming Ding
• Enable/Disable of Duress	• Alarm Sounder Duration
• Multiple Alarm Reporting	• User Codes (auto per partition)
• Quick Arm enable/disable	• 4 digit access code
• Inhibit Bypass of one Zone	

II. ZONE CONFIGURATIONS

ZONE TYPE DEFINITIONS

The VISTA 4140XMPT System allows up to 64 zones of hard-wire, polling loop and/or wireless protection, distributed among up to 8 partitions. Each zone must be assigned to a zone type, which defines the way in which the system responds to faults in that zone. In addition, there are three keypad activated zones (PANIC keys, see note below) for each partition, a polling loop supervision zone, and four RF supervisory zones, two for each 4280 or 4280-8 RF Receiver installed.

TYPE 1: ENTRY/EXIT #1

Used for the primary entry/exit route (ex: front door, main entrance).

TYPE 2: ENTRY/EXIT #2

Used for a secondary entry/exit route (ex: Garage door, loading dock door, basement door), where more time might be needed to get to and from the console.

TYPE 3: PERIMETER BURGLARY

Used for exterior doors and/or windows which require an instant alarm when violated.

TYPE 4: INTERIOR BURGLARY (FOLLOWER)

Used for areas where an entry delay is required only if an entry/exit delay zone is faulted first.

TYPE 5: DAY/NIGHT BURGLARY

Used for zones which contain a foil-protected door or window (such as in a store), or to a zone covering a sensitive area such as a stock room, drug supply room, etc., or other controlled access area where immediate notification of an entry is desired.

TYPE 6: 24 HOUR SILENT ALARM

This zone type is generally assigned to a zone containing a Hold-up or Panic button that is designed to initiate an alarm report to the Central Station, but which produces no visual displays or alarm sounds (ex: banks, jewelry counters).

TYPE 7: 24 HOUR AUDIBLE

This type also assigned to a zone containing a Panic button, but which will initiate an audible alarm in addition to an alarm report to the Central Station (ex: bedside panic).

TYPE 8: 24 HOUR AUXILIARY

This type assigned to a zone containing a button for use in personal emergencies or to a zone containing monitoring devices such as water sensors, temperature sensors, etc. Designed to initiate an alarm report to the Central Station and only provides Console alarm sounds and alarm displays.

TYPE 9: SUPERVISED FIRE

Used for zones containing smoke detectors, heat detectors, pull stations, etc. An open in this zone will initiate a trouble signal. A short in this zone will initiate a fire alarm (pulsed external sounder and report to central station).

TYPE 10: INTERIOR BURGLARY (DELAY)

This type is similar to type 4, except that entry delay begins whenever sensors in this zone are violated, regardless of whether or not an entry/exit delay zone was faulted first.

NOTE FOR PANIC KEYS

Keypad panic zones share the same zone response type for all 8 partitions, but panics may be individually enabled for each partition.

IMPORTANT! FAULT ANNUNCIATION

Polling loop and RF faults (zones 88-91 & 97) will report as trouble conditions only, and as such, should be assigned either zone type 00 if no annunciation is desired, or zone type 05 if annunciation as trouble condition is desired. See FAULT ANNUNCIATION notes in POLLING LOOP and WIRELESS EXPANSION sections for more information.

BASIC 9 HARD-WIRED ZONES

ZONE 1

This zone has a 350 millisecond response and can be assigned to any zone type. It can be EOLR supervised or closed circuit unsupervised as required (the red PCB jumper is used to make this selection). This zone is the only zone that can support up to 16 2-wire smoke detectors. See SMOKE DETECTOR CONFIGURATION section for a list of compatible detectors.

When use of the EOLR is selected (red jumper intact), both open circuit and closed circuit devices can be used. Connect closed-circuit devices in series with the loop wires, and connect open circuit devices in parallel across the loop wires. The 2,000 ohm EOLR must be connected across the loop wires at the last device. When use of the EOLR is disabled (red jumper cut), only closed circuit devices can be used.

NOTE: EOLR supervision must be selected when this zone is used as a fire zone. Maximum zone resistance, excluding EOLR, is 100 Ohms.

ZONE 9

This zone is unsupervised and can be assigned to any zone type except fire. Only closed-circuit devices can be used. Connect these devices in series with one another between terminals 22 & 23 (see SUMMARY OF CONNECTIONS Diagram). This zone can be programmed for either normal response (350msec, the default response) or for fast response (10msec). This zone is suitable for monitoring fast acting glass break sensors or vibration sensors when programmed for fast response. Avoid using mechanical

magnetic or relay type contacts in this zone when programmed for fast response. Note that the maximum resistance for this zone is 300 ohms.

ZONES 2 THROUGH 8

These zones have a 350 millisecond response and can be assigned to any zone type. They can be EOLR supervised or closed circuit unsupervised, as required (program field *41 determines whether or not these zones will use the 2,000 ohm EOLR: Enter [1] in field *41 to disable the use of EOLR's on zones 2 through 8). If programmed for use with EOLR's, both closed-circuit and open-circuit devices can be used with the 2,000 ohm EOLR resistor across the loop wires at the last device. If the use of EOLR's is disabled (*41=1), only closed-circuit devices can be used.

Zone 8 has the added capability of supporting up to 50 2 wire, latching type glass break detectors. See GLASS BREAK DETECTORS section for a list of compatible detectors. These detectors may be reset at the console in the same manner as two wire smoke detectors. (i.e. second entry of "OFF" sequence). Zone 8 should be configured as an EOLR type zone when glass break detectors are used. The maximum resistance per zone, excluding EOLR, is 300 ohms for zones 2-7, and 100 ohms for zone 8.

ADVISORY

NOTE: If latching type devices are installed on both zones 1 & 8, and these zones are assigned to different partitions, there is a possibility that, if both devices go into alarm at the same time, the resetting of one device could cause the loss of alarm memory in the other device.

2-WIRE POLLING LOOP EXPANSION (Zones 10 through 64)

GENERAL INFORMATION

The 4140XMPT provides a built-in 2-wire polling loop interface which allows the number of zones to be expanded from the basic 9 zones to up to 64 zones using various RPMs, and the 4280 RF Receiver. See below for a list of compatible sensors.

The polling loop provides power to sensors and serves as a communication path between the panel and sensors. Each sensor must be assigned a unique address ID number (from 10-64) before being connected to the polling loop. Most sensors have DIP switches for this purpose. See the DIP SWITCH SETTING TABLE FOR POLLING LOOP DEVICES for information on how to assign ID numbers using DIP switches. Care must be taken to assign unique ID numbers to each sensor in order to allow the panel to supervise and provide unique console status indications for individual sensors.

Connect these sensors to terminals 24 & 25. Sensors can be connected to a single run, or groups of sensors may be connected to separate wire runs without affecting the panel's ability to supervise individual sensors. Follow the wiring instructions provided with individual sensors (4190WH wiring diagram is provided at the end of this manual). Be sure to observe sensor polarity when wiring. The maximum allowable wire run length between the panel and the last sensor on a given wire run is as follows:

#22 gauge @ 650 feet max	NOTE
#20 gauge @ 950 feet max	Twisted pair recommended
#18 gauge @ 1500 feet max	for all normal wire runs.
#16 gauge @ 2400 feet max	

IMPORTANT: The maximum combined polling loop run is 4000'. If using shielded wire, the maximum is 2000'. If longer wire runs are needed, a 4197 Loop Extender Module must be used (see instructions included with the 4197).

POLLING LOOP DEVICES

See PERIPHERAL DEVICES section for compatible polling loop smoke detectors and passive infrared motion detectors.

4208 Eight Zone Polling Loop Expansion Module

- Used to supervise up to 8 hard-wired devices via the polling loop. NOTE: Does not support 2-wire smoke detectors.
- Set DIP switches to identify 8 zones.
- The first two zones can be either normal or fast response (DIP switch selectable).
- All zones are EOLR supervised (first six zones = 4.7k ohms, last two zones = 30k ohms), provided with the 4208.

4190WH Two Zone Remote Point Module

- Used to supervise 2 hard-wired devices via the polling loop.
- DIP switch programmable.
- The left zone can be EOLR supervised, if necessary, and can accept either open or closed circuit sensors. The right zone is unsupervised and can accept closed circuit sensors only. Refer to the 4190WH OPERATION section at the end of this manual for more information.

INTERCOM INTERFERENCE

If an intercom system is being used, the polling loop wires must be as far from the intercom wiring as possible (minimum 6"). If this spacing cannot be achieved, shielded wire must be used. If this is not done, interference on the intercom system might occur. Also note that the maximum total wire length supported is cut in half when shielded wire is used.

ADVISORIES

The maximum allowable current draw on the polling loop is 64mA. Refer to the POLLING LOOP CURRENT DRAW WORKSHEET (found in the POWERING THE SYSTEM section of this manual) for current draws of various polling loop devices. If more than 64mA is being drawn, use of the 4197 provides another loop with 64mA available.

Make certain to include the total current drawn on the polling loop in the AUXILIARY CURRENT DRAW WORKSHEET (see POWERING THE SYSTEM section) when figuring the total auxiliary load on the panel's power supply.

IMPORTANT! FAULT ANNUNCIATION

Since the polling loop and the RF receiver(s) are shared among the 8 partitions, the scheme for annunciating their failure is as follows:

Respective faults (for zones 88-91 & 97) will report as trouble conditions only, and as such, should be assigned either zone type 00 if no annunciation is desired, or zone type 05 if annunciation as trouble condition is desired. If the polling loop or RF link fails, the corresponding zone number will display a trouble condition for each partition that uses the device that failed. In addition, all zones associated with that device will indicate a fault condition. The trouble condition will not interfere with the ability to arm the partition, but the faults must first be bypassed.

4194 Surface Mounted Reed Contact (Wide Gap)

- Wide gap surface mounted reed contact with built-in RPM, which is DIP switch programmable.

4197 Polling Loop Extender Module

- Can be used if the 2-wire polling loop must be greater than the recommended length (4000' max). By installing a 4197 at the end of the first loop, the polling loop can be continued. If more than 64mA needs to be drawn from the polling loop to power RPMs, use of the 4197 provides another loop with 64mA available.
- Connects to the polling loop and is powered from auxiliary power or by a separate 729 power supply with battery backup.

WIRELESS EXPANSION (Zones 1-63)

4280/4280-8 RF RECEIVER

The system supports up to 63 wireless transmitters (5700 series), plus a 5727 wireless keypad. To expand the system using wireless, one or two 4280 RF Receivers (or 4280-8 if only 8 wireless zones are used) must be connected to the polling loop. The 4280 receives status and alarm signals from wireless transmitters (@345MHz USA; 315MHz Canada) within a nominal range of 200 feet, and relays this information to the control via the polling loop. Two 4280s can be used to provide either a greater area of coverage, or provide redundant protection.

IMPORTANT: Note that if using two RF Receivers, one of them must be powered from auxiliary power.

For more information regarding the 4280 installation, refer to the installation instructions provided with the 4280.

NOTE: Unless stated otherwise, references to the 4280 Receiver represent the 4280 and/or 4280-8 Receivers.

PROGRAMMING NOTE

All RF zones must be designated as such in their respective program fields (1*18-1*25). Any zone from 1-63 can be designated as an RF zone. To enable a zone as wireless, simply enter a "1" in the location for that zone, or use the #93 ZONE PROGRAMMING method. Be careful when designating RF zones. If you want a zone to be either hard-wired or on the polling loop, but accidentally enable it as RF, the system will ignore that zone. RF enable overrides wired.

If using a 4280-8, only up to 8 zones can be enabled as RF zones. If more than 8 zones are enabled, the message "SET-UP ERROR" will be displayed.

SUPERVISION

Each transmitter (except 5701 and 5727) is supervised by a check-in signal that is sent to the receiver at 70-90 minute intervals. If at least one Check-in is not received from a transmitter within a programmed interval (field 1*31), the console will display the transmitter number and "CHECK" will be displayed.

Each transmitter (including 5701 and 5727) is also supervised for low battery conditions, and will transmit a low battery signal to the 4280 when the battery has approximately 30 days of life remaining. The console will display the transmitter number and "LO BAT".

NOTE: After replacing a low or dead battery, activate the transmitter and enter the security code + OFF to clear its memory of the "Low Battery" signal.

The 4280 itself is also supervised three ways:

1. If the cover of the 4280 is removed, a TROUBLE will be displayed for zones 89 or 91 (if type 05 is assigned in field 1*09).
2. If the connection is broken between the 4280 and the control panel, a TROUBLE will be displayed for zones 89 or 91 (if type 05 is assigned in field 1*09). In addition, all zones associated with the RF device will report a trouble condition.
3. If, within a programmed interval of time, the 4280 does not hear from any of its transmitters, a TROUBLE will appear for zones 88 or 90 (if type 05 is assigned in field 1*09).

HOUSE IDENTIFICATION

The 4280 responds only to transmitters with the same house ID (DIP switch programmable from 01-31). This prevents system interference from transmitters in other nearby systems. To make sure you do not choose a House ID that is in use nearby, put the system in the Sniffer Mode, which is described later in this section.

TRANSMITTER IDENTIFICATION

Each transmitter has its own unique ID number (Zone #), which is DIP switch programmable in each unit. Whenever a transmission takes place, either for an alarm, fault, check-in or low battery, this ID number is sent along with the message to the 4280 which, in turn, relays this information to the control panel, which displays the condition and zone number on the console. See the DIP SWITCH TABLES FOR WIRELESS DEVICES at the end of this manual, for individual transmitter settings.

SNIFFER MODE FOR HOUSE ID (code + [#] + [2])

To check for house IDs being used in nearby systems, set the DIP switches in the 4280 for a House ID of "00" (all switches up), then enter your "Installer Code" + [#] + [2]. The 4280 will now "sniff" out any House IDs in the area and display them. Keeping the 4280 in this mode for about 2 hours will give a good indication of the house IDs being used. To exit the Sniffer Mode, simply key your installer code + OFF, then set your house ID to one not displayed in the "Sniffer Mode".

IMPORTANT: Since Sniffer Mode effectively disables RF point reception, Sniffer Mode cannot be entered while any partition is armed.

CHECKING TRANSMITTER HOUSE IDs

(code + [#] + [3])

To check that all transmitters have been set for the proper house ID, set the 4280 to the proper house ID and enter the Installer code + [#] + [3]. All transmitters that have been enabled for the partition in which the test was initiated will be displayed. As each transmitter checks in (up to 2 hours), its ID number will disappear. A faster way to do this is to fault each transmitter, which causes a transmission to be sent to the 4280. When all transmitters have checked in, there should be no ID numbers displayed.

NOTE: Repeat this procedure for each partition that uses RF transmitters.

BUILT-IN "GO/NO GO" TEST MODE (Patented)

This mode helps determine the best location for each transmitter and is activated by putting the control panel in the TEST mode and removing the 4280's cover. The receiver's sensitivity is reduced by half. Once transmitters are placed in their desired locations and the approximate length of wire to be run to sensors is connected to the transmitter's screw terminals, open circuit each transmitter. *Do not conduct this test with your hand wrapped around the transmitter.*

If a single 4280 is used, the console will beep three times to indicate signal reception. If two 4280s are used, the console will beep once if the first 4280 received the signal, twice if the second 4280 received the signal and three times if both receivers heard the signal (which is desirable for redundant configurations).

If the console does not beep, reorient or move the transmitter to another location. Usually a few inches in either direction is all that is required.

To exit this mode, replace the 4280's cover, then enter the installer code and press OFF. Note that the Receiver's sensitivity is fully restored when the cover is replaced.

IMPORTANT BATTERY NOTICE

The VISTA wireless transmitters are designed to provide long battery life under normal operating conditions. Longevity of batteries may be as much as 4-7 years depending on the environment, usage, and the specific wireless device being used. External factors such as humidity, high or low temperatures, as well as large swings in temperature may all reduce the actual battery life in a given installation. The VISTA wireless system can identify a true low battery situation, thus allowing the dealer or user of the system time to arrange a change of battery and maintain protection for that given point within the system.

WIRELESS ZONE TYPES

Each RF zone can be programmed to respond as any zone type such as ENTRY/EXIT, INTERIOR, PERIMETER, etc. (see the ZONE TYPES section for a complete explanation of each zone type). Desired alarm responses are as follows:

ZONE TYPE	TRANSMITTER ID #
Entry/Exit Burg	1 through 47 *
Perimeter Burg	1 through 47 *
Interior Burg	1 through 47 * 32 through 47 * (5775)
Fire	48 through 63 * 48 through 55 ** (5706)
24 Hour Panic (silent or audible)	48 through 63 * 62 or 63 *** (5701)
Day/Night Burglary	1 through 47 *
24 Hour Auxiliary	1 through 47 *

NOTES:

- * Note that zones 1-63 can be used, but have the following limitations: Transmitters set for zones 48-55 will transmit once every 12 seconds while the zone is faulted. Transmitters set for zones 56-63 will transmit once every 3 seconds while faulted. These two ranges of zone numbers could adversely affect transmitter battery life. Transmitters set for an ID of 32 through 47 will have a 3 minute lock-out between transmissions. Use this last range of zone ID numbers for sensors protecting frequently used doors or windows to conserve battery life.
- ** Transmitter IDs 48 through 55 have highest signal priority.
- *** Transmitter IDs 62 and 63 are unsupervised to allow removal of the 5701 off premises – signal priority is lower than that of fire, but higher than burglary.

ADVISORIES

1. Do not place transmitters on or near metal objects. This will decrease range and/or block transmissions.
2. Place the 4280 in a high, centrally located area for best reception. Do not place receiver on or near metal objects.
3. The 4280 receiver must be at least 10 feet from the Control panel or any remote consoles to avoid interference from their microprocessor.
4. When connecting a door/window contact to a 5711, 5711WM, or 5715 transmitter, avoid a wire length of 20-24 inches. This particular length decreases range. A shorter or longer length has no effect.

UL NOTE: For UL Household Burglary Installations, wired loops connected to these devices cannot exceed 3 feet.

5. If dual 4280s or 4280-8s are used:
 - A. Both must be at least 10 feet from each other, as well as from the Control panel and remote consoles.
 - B. One of the 4280s or 4280-8s must be powered from Aux. power so as not to exceed 64 mA polling loop current rating.
 - C. The house IDs must be the same.
 - D. Using two Receivers does not increase the number of transmitters the system can support (63 transmitters, plus a wireless keypad).

6. Refer to the maximum polling loop wire runs described in the POLLING LOOP section when connecting 4280s to the polling loop.

IMPORTANT: The maximum combined polling loop run is 4000'. If using shielded wire, the maximum is 2000'.

FAULT ANNUNCIATION

Since the polling loop and the RF receiver(s) are shared among the 8 partitions, the scheme for annunciating their failure is as follows:

Respective faults (for zones 88-91 & 97) will report as trouble conditions only, and as such, should be assigned either zone type 00 if no annunciation is desired, or zone type 05 if annunciation as trouble condition is desired. If the polling loop or RF link fails, the corresponding zone number will display a trouble condition for each partition that uses the device that failed. In addition, all zones associated with that device will indicate a fault condition. The trouble condition will not interfere with the ability to arm the partition, but the faults must first be bypassed.

WIRELESS DEVICES

See the PERIPHERAL DEVICES section for compatible wireless smoke detectors and passive Infrared motion detectors.

5701 Panic Transmitter

- Programmable for either silent or audible 24 hour alarm (can be DIP switch programmed for zones 62 or 63).

5711 Slimline Door/Window Transmitter

- Can be used with any closed circuit sensor. NOTE: Can be used on any zone 1-63 but, if programmed for zones 32-47, there will be a 3 minute lock-out between transmissions.

5711WM Door/Window Transmitter w/Reed Switch

- Slimline door/window transmitter with built-in reed switch (magnet included). Can be used with any closed circuit sensor. NOTE: Can be used on any zone 1-63 but, if programmed for zones 32-47, there will be a 3 minute lock-out between transmissions.

5715WH Universal Transmitter

- DIP switch selectable for fast response, open or closed circuit sensor usage, and has a tamper protected cover. Use in applications where open circuit heat detectors are needed or where fast response devices are needed. NOTE: Can be used on any zone 1-63 but, if programmed for zones 32-47, there will be a 3 minute lock-out between transmissions.

5727 Wireless Keypad

- Wireless keypad that can be used to turn the burglary protection on and off, and features the same built-in panic functions as wired consoles for either silent or audible 24 hour alarm. An LED indication lights each time a key is pressed to verify transmission (LED located in the [*] READY key).
- The keypad is identified as zone "00" when it transmits low battery messages. The keypad panics are identified as "99" for [*] + [#], "96" for [#] + [3], and "95" for [*] + [1] if programmed.

5716 Door/Window Transmitter

- Can be used with any open or closed circuit sensor (DIP switch selectable), and features a built-in reed switch. NOTE: Can be used on any zone 1-63 but, if programmed for zones 32-47, there will be a 3 minute lock-out between transmissions.

III. PERIPHERAL DEVICES

REMOTE CONSOLES

GENERAL

The 4140XMPT supplies up to 750 mA of auxiliary power for remote consoles, polling loop devices and/or other auxiliary devices such as motion detectors or 4-wire smoke detectors*. The 4140XMPT supports, independent of auxiliary power considerations, up to 16 5137AD addressable remote consoles. Up to 8 consoles can be powered from the auxiliary power output provided that the total current drawn from this output does not exceed 750 mA. You must keep this in mind when adding remote consoles so you don't overdraw current from the panel. This would result in a battery which does not charge properly or possibly a tripped auxiliary solid state circuit breaker.

If the auxiliary load is determined to be greater than 750 mA, then additional consoles can be powered from a separate power supply. The diagram on the next page shows how to make connections to the separate power supply.

* 4-wire smoke detectors cannot be used in UL Listed applications.

5137AD ADDRESSABLE ALPHA LCD CONSOLE

- Equipped with a programmable 2-line, 32-character (16 characters per line), backlit alphanumeric LCD for complete zone identification in English language (if descriptors are programmed). Keys are also backlit.
- An alarm sounder is built in, eliminating the need for a separate indoor sounder.
- DIP switch selectable ID number, which allows console to display unique, partition specific messages.
- 90mA current draw.

PROGRAMMING THE CONSOLES

Consoles must be programmed for type, partition number and console sounder suppression options. Refer to the PROGRAMMING THE SYSTEM section (DEVICE PROGRAMMING) for instructions.

WIRING CONSOLES

Consoles may be wired to a single wire run or individual consoles may be connected to separate wire runs. The maximum wire run length from the panel to a console which is homerun back to the panel must not exceed:

- #22 gauge @ 450 feet maximum
- #20 gauge @ 700 feet maximum
- #18 gauge @ 1100 feet maximum
- #16 gauge @ 1750 feet maximum

NOTE: The length of all wire runs combined must not exceed 2000 feet when unshielded quad conductor cable is used (1000 feet if shielded cable is used.)

If more than one console is wired to a run, then the above maximum lengths must be divided by the number of consoles on the run (i.e. the maximum length would be 225 feet if two consoles are wired on a #22 gauge run).

ADDRESSABLE CONSOLE DIP SWITCH SETTINGS
IMPORTANT! You must select an address of 0, 1, 2, or 3 if standard defaults are to be programmed, since these are the only console addresses enabled by the standard default.

ID	DIP SETTINGS				
	1	2	3	4	5
0	dn	dn	dn	dn	dn
1	dn	dn	dn	dn	UP
2	dn	dn	dn	UP	dn
3	dn	dn	dn	UP	UP
4	dn	dn	UP	dn	dn
5	dn	dn	UP	dn	UP
6	dn	dn	UP	UP	dn
7	dn	dn	UP	UP	UP
8	dn	UP	dn	dn	dn
9	dn	UP	dn	dn	UP
10	dn	UP	dn	UP	dn
11	dn	UP	dn	UP	UP
12	dn	UP	UP	dn	dn
13	dn	UP	UP	dn	UP
14	dn	UP	UP	UP	dn
15	dn	UP	UP	UP	UP
16	UP	dn	dn	dn	dn
17	UP	dn	dn	dn	UP
18	UP	dn	dn	UP	dn
19	UP	dn	dn	UP	UP
20	UP	dn	UP	dn	dn
21	UP	dn	UP	dn	UP
22	UP	dn	UP	UP	dn
23	UP	dn	UP	UP	UP
24	UP	UP	dn	dn	dn
25	UP	UP	dn	dn	UP
26	UP	UP	dn	UP	dn
27	UP	UP	dn	UP	UP
28	UP	UP	UP	dn	dn
29	UP	UP	UP	dn	UP
30	UP	UP	UP	UP	dn
31	UP	UP	UP	UP	UP

IMPORTANT!

The Standard Default enables only these 4 console addresses (0-3). Set at least one console to one of these addresses. Use programming mode to enable other console addresses.

NOTE: Some versions of the 5137AD console may have a 6 position DIP switch. The sixth switch is not used with the 4140XMPT and should be put in the UP position.

ADDRESS "31"

Do not use address 31 with the 4140XMPT. Address 31 causes the console to operate in non-addressable mode (i.e. works like a standard, non-addressable 5137 console).

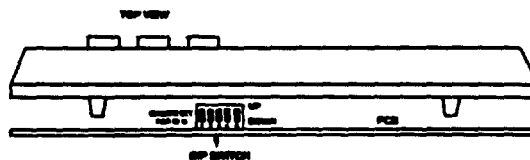
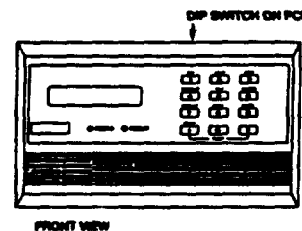

Figure 2. ADDRESSABLE CONSOLE

SURFACE MOUNTING THE CONSOLES

Note that field wiring to the consoles must be completed before the consoles can be mounted.

1. Use the template provided (on a separate sheet) to mark the positions on the wall for the mounting holes and the cut-out for the wiring.
2. Pull the interface wiring in the wall through the cut-out.
3. Remove the console's back cover. Remove the securing screw at the front of the console to release the back cover.
4. Pass the interface wiring through the opening in the back cover, then mount the back cover to the wall with screws.
5. Splice the interface wiring to the wires on the interface connector supplied with consoles). Insulated solderless wire splices (eg. 311) may be used for splicing.
6. Attach the main body of the console to the wall-mounted back cover. The console is properly attached when it snaps into place. Use the securing screw (previously removed) to secure the console to the back cover.

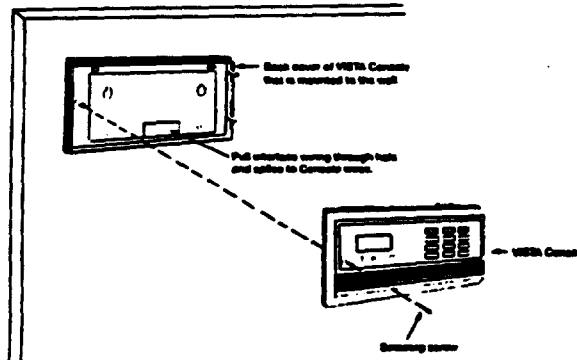

Figure 3. SURFACE MOUNTING CONSOLES

POWERING ADDITIONAL CONSOLES

Up to 8 consoles can be powered from the 4140XMPT auxiliary power output provided that the 750mA rating is not exceeded. The 4140XMPT's backup battery will supply power to these consoles in the event that AC power is lost. Connect these consoles using console wire colors shown.

Additional consoles can be connected to the system by using a regulated, 12VDC power supply (eg. 487-12 supplies 12V, 250mA; 488-12 supplies 12V, 500mA). Note that the maximum number of consoles supported by the system is 16. Connect additional consoles as shown below, using the console wire colors shown. Each 5137AD draws 90mA. Make sure to observe the current ratings for the power supply used.

Wire run lengths from the 4140XMPT to consoles are listed on the previous page (maximum combined wire run lengths for all consoles must not exceed 2000', or 1000' if shielded cable is used).

IMPORTANT: Make connections directly to the screw terminals as shown. Make no connection to the console blue wire.

The 487-12/488-12 power supplies have a backup battery which can power these consoles in the event of AC power loss. Note that consoles powered from supplies which do not have a backup battery will not function when AC power is lost. In this case, make sure to power at least one console from the 4140XMPT's auxiliary power output.

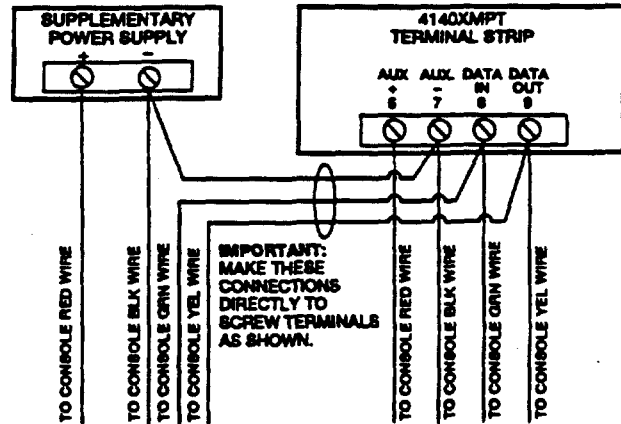

Figure 4.

FLUSH MOUNTING WITH TRIM RING KIT (5137TRK)

1. Cut out a 4-3/4" high by 8" wide opening in the wall between studs, no less than 1-1/2" from either stud. Use the template provided to mark the cut-out.
2. Insert the four 1-1/2" long #6 screws through the mounting holes in the Trim Ring and then attach the four metal securing clips, as shown in the diagram. Use only two or three turns of each screw, allowing the metal clips to hang freely. The clips must not protrude beyond the sides of the Trim Ring or you will not be able to install the Trim Ring into the cut-out in the next step.
3. Install the trim ring into the opening in the wall with the hinge clasps to the right. Making sure the trim ring is straight, tighten each clip screw, making sure that the attached clip slides down into its guide track.
4. Install the Console as follows: Engage the hinge clasps on the trim ring with the notches located in the back (right-hand side) of the Console's front panel. Swing the left side of the panel toward the trim ring (the panel will pivot on the hinge clasps), and press firmly until the panel "snaps" closed.
5. Use the panel securing screw (supplied with the Console) to secure the left side of the panel.

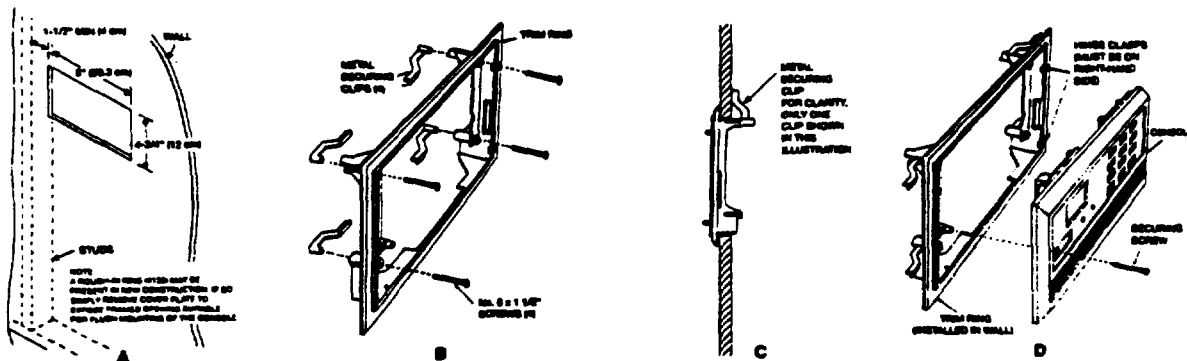

Figure 5. FLUSH MOUNTING THE REMOTE KEYPADS

ADJUSTING THE ALPHA CONSOLE LCD VIEWING ANGLE (5137AD ONLY)

Insert the end of the small, key-shaped tool (supplied) into the small hole to the left of the console display window (the adjustment screw is recessed in this hole). Turn the adjustment screw to the left or right until optimum viewing is achieved. Be sure to take the height of the users into account when making this adjustment.

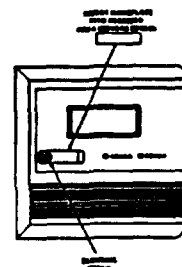

Figure 6. ADJUSTING THE VIEW ANGLE/INSERTING THE NAMEPLATE

EXTERNAL SOUNDERS

RELAY OUTPUT

The 4140XMPT provides a wet bell relay output which is used to power external alarm sounders. Connections are made to terminals 4 (positive output) and 5 (negative return). See SUMMARY OF CONNECTIONS Diagram.

NON-UL INSTALLATIONS

For non-UL installations, the total current drawn from this output cannot exceed 2.8 amps. A battery must be installed since this current is supplied by the battery. Up to two 702 sirens can be used, wired in series. Up to two 719 sirens can be used, wired in parallel.

UL INSTALLATIONS

For UL installations, the total current drawn from this output and the auxiliary power output, combined, cannot exceed 750 mA. For example, if two BRK PA400 piezo alarm sounders wired in parallel are used (24 mA total), then 726 mA (750 mA - 24 mA) is available for auxiliary power output use.

IMPORTANT: Going beyond the above mentioned limits will overload the power supply or may possibly trip the bell output thermal circuit breaker.

COMPATIBLE SOUNDERS

702 Outdoor Siren

- Self-contained siren (driver built-in) and weatherproof for outdoor use. Can be wired for either a steady or yelp sound and is rated at 120 dB @ 10 feet. This siren can also be tamper protected, or can be mounted in a metal cabinet (716), which can be tamper protected.

719 Outdoor Siren (Compact)

- Compact, self-contained siren (driver built-in), and weatherproof for outdoor use. Can be wired for either a steady or yelp sound, and is rated at 90 dB @ 10 feet. A 708BE cabinet is available, which can be tamper protected if necessary.

740 High Intensity Sounder

- Compact high intensity sounder rated at 123 dB @ 10 feet. This sounder emits an 'ear piercing', high frequency sound. This sounder can be mounted indoors (bracket included) or outdoors (in 708BE cabinet).

ABB1031 Motor Bell & Box

- AMSECO motor bell & box, rated at 81 dB @ 10 feet.

PA400B (beige)/PA400R (red) Indoor Piezo Sounder

- BRK indoor piezo sounder (red or beige), rated at 90 dB @ 10 feet.

PASSIVE INFRARED MOTION DETECTORS

Refer to the PIR Installation Instructions for installation hints as to the best mounting location.

4278 Quad Element Polling Loop PIR

- Quad element PIR with built-in RPM which is DIP switch programmable and connects directly to the polling loop. Includes mirrors for both wide angle and curtain/long range applications. Features an auxiliary sensor loop that permits connection of another nearby closed circuit alarm sensor (reed contact, etc.).

4275 Dual Element Polling Loop PIR

- Dual element PIR with built-in RPM which is DIP switch programmable. Includes mirrors for both wide angle and curtain/long range applications and can use the 1875PA Pet Alley mirror. Built-in selectable pulse count capability.

5775 Wireless PIR

- The 5775 is a battery operated, wireless, dual element passive infrared motion detector with built-in selectable pulse count, that can be monitored by a 4280 (4280-S) wireless receiver, and is DIP switch programmable for zones 32-47. NOTE: There is a 3 minute lock-out between transmissions to preserve battery life.

SMOKE DETECTORS

ZONE 1

When programmed as an EOLR supervised FIRE zone (red jumper intact and zone type 09 in program field *02), up to sixteen 2-wire smoke detectors can be used. When programmed for fire, the second CODE + OFF sequence momentarily interrupts power to reset the smoke detectors.

COMPATIBLE SMOKE DETECTORS

DETECTOR TYPE	BRK DEVICE MODEL #
Photoelectric, direct wire	BRK2400
Photoelectric w/heat sensor, direct wire	BRK2400TH
Photoelectric w/B401B base	BRK2451
Photoelect. w/heat sensor & B401B base	BRK2451TH
Ionization, direct wire	BRK1400
Ionization w/B401B base	BRK1451
Photoelectric duct detector w/DH2851DC base	BRK2851DH
Ionization duct detect. w/DH1851DC base	BRK1851DH

ADVISORIES

If the EOLR is not at the end of the loop, the zone is not properly supervised. The system may not respond to an open circuit within the zone.

The alarm current provided by this zone is sufficient to support operation of only one detector in the alarmed state. See Advisory in BASIC 9 HARD-WIRED ZONE section.

ZONES 2 THROUGH 8

These zones can support as many 4-wire smoke detectors as can be powered, when programmed as a FIRE zone, type 09, in program field *02. There are only two requirements: (1) The zones must be configured for EOLR supervision, and (2) a normally-closed, momentary switch must be installed in series with the power to the detectors in order to allow reset of the smoke detectors after an alarm. The detectors must be wired in parallel, with the EOLR at the last detector for full supervision. To supervise power, a BRK No. A7771801 EOL Relay Module is recommended.

POLLING LOOP SMOKE DETECTORS

Can be added to the 2-wire Polling Loop on zones 10 through 64 (as programmed in fields *03, *04, *05, 1*01, 1*02, 1*03, 1*04 and 1*05). These detectors are wired in parallel to the polling loop, and do not need auxiliary power or a separate reset switch. The polling loop provides power and reset signals to the detectors, as well as alarm and trouble signals from the detectors. Refer to the maximum polling loop wire runs listed in the POLLING LOOP section when using polling loop smoke detectors.

4182SD Photoelectric Polling Loop Smoke Detector

- One piece photoelectric smoke detector with built-in RPM which is DIP switch programmable.

4182SDT Photoelectric Polling Loop Smoke Detector w/Heat Detector

- One piece photoelectric smoke detector with 135°F (57°C) heat detector, and built-in RPM which is DIP switch programmable.

4182CP Ionization Smoke Detector

- One piece products of combustion ionization detector with built-in RPM which is DIP switch programmable.

WIRELESS SMOKE DETECTOR

5706 Wireless Photoelectric Smoke Detector

- One piece smoke detector with built-in transmitter (DIP switch programmable for zones 48-55). Built-in UL Listed 85 dB piezoelectric alarm sounder and audible low battery warning.

GLASS BREAK DETECTORS

GENERAL INFORMATION

Zone 8 can support 2-wire, latching type glass break detectors when configured as an EOLR supervised zone. The second CODE + OFF sequence momentarily interrupts power to this zone to reset devices wired to it. Use detectors which are compatible with the ratings below:

Standby Voltage: 5VDC - 13.8VDC

Standby Resistance: Greater than 20k ohms (equivalent resistance of all detectors in parallel)

Alarm Resistance: Less than 1.1k ohms (see note below)

Alarm Current: 2 mA - 10 mA

Reset Time: Less than 6 seconds

The IEI 735L series detectors have been tested and found to be compatible with these ratings. Up to 50 IEI 735L detectors, connected in parallel, may be used (the alarm current provided by this zone is sufficient to support operation of only one detector in alarmed state). Follow the manufacturer's recommendations on proper installation.

NOTES:

Detectors which exceed 1.1k ohms in alarm, but maintain a voltage drop in alarm of less than 3.8 volts can also be used.

Use of N.O. or N.C. contacts on the same zone may prevent proper glass break detector operation.

See Advisory in BASIC 9 HARD-WIRED ZONE section.

PHONE LINE CONNECTIONS

GENERAL INFORMATION

Incoming phone line and handset wiring is connected to the main terminal block as follows (refer to SUMMARY OF CONNECTIONS Diagram):

TB1-26: Local Handset (TIP)

TB1-27: Local Handset (RING)

TB1-28: Incoming Phone Line (TIP)

TB1-29: Incoming Phone Line (RING)

If it is desired to connect the panel to phone lines that require ground start capability, then a 675 Ground Start Module must be used. This module is triggered by one of the outputs on the connector labeled J7 (see CONNECTOR J7 TRIGGER OUTPUTS).

WARNING: To prevent the risk of shock, disconnect phone lines at telco jack before servicing the panel.

IMPORTANT

If the communicator is connected to a telephone line inside a PABX, be sure the PABX has a back-up power supply that can support the PABX for 24 hours. Many PABXs are not power backed up and connection to such a PABX will result in a communication failure if power is lost.

CONNECTOR J7 TRIGGER OUTPUTS

(Ground Start Module, Keyswitch, Remote Console Sounder, etc.)

GENERAL INFORMATION

Connector J7, located on the right hand side of the main PCB provides 4 trigger outputs for operating the 675 Ground Start Module, the 4146 Keyswitch, a remote console sounding piezo, and for triggering auxiliary alarm signalling equipment (LORRA's, STU's, etc.)

The pin assignments of this connector are shown below. Use only the 4142TR 9-wire cable (available as an option) for making connections to this connector.

Output 1 is rated as follows:

When Activated: 10 - 13.8 VDC through 4K ohms

When De-activated: 100 ohms to ground

Other outputs are rated as follows:

When Activated: 10 - 13.8 VDC through 5K ohms

When De-activated: 1k ohms to ground

Output 1 operates, by default, as a trigger for the 675 ground start module. This output may optionally be programmed to operate as an open/close trigger or as a remote console sounder output. Only one of these options may be used at any time.

Outputs 2 & 4 operate, by default, as Fire and Silent Panic/Duress triggers respectively. These triggers may optionally be programmed to act as Arm and Ready status indicators when it is desired to use the 4146 keyswitch.

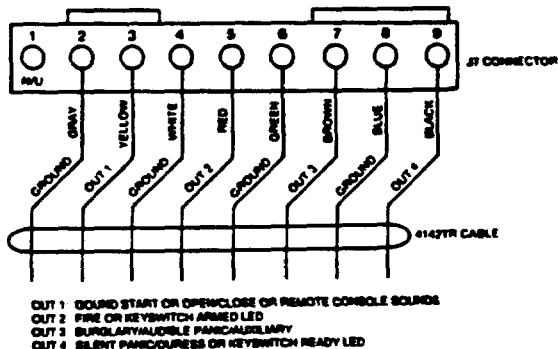

Figure 7. CONNECTOR J7

GROUND START MODULE

Not intended for use in UL Listed applications.

An optional 675 Ground Start module can be used for installations having telephone lines which require ground start instead of loop start operation to obtain dial tone from the telco central office. If used, program field 1*46 must be set to "0" (factory default) and the 675 Ground Start Module must be connected to the panel's J7 connector trigger output 1, to auxiliary power, and to the "RING" side of the telephone line as shown in the diagram below.

Use the following procedure to determine which side of the telephone line is the "RING" side:

- Connect the "+" lead of a DC voltmeter to earth ground, and the "-" lead to one side of the telephone line.
- The wire which reads +50VDC is the "RING" side.

When the panel has a message to transmit to the central station, it will seize the line, go off hook, and then trigger the 675 module to connect the "RING" side of the telephone line to earth ground. The panel will cause the module to break the connection between "RING" and earth ground when a dial tone is obtained.

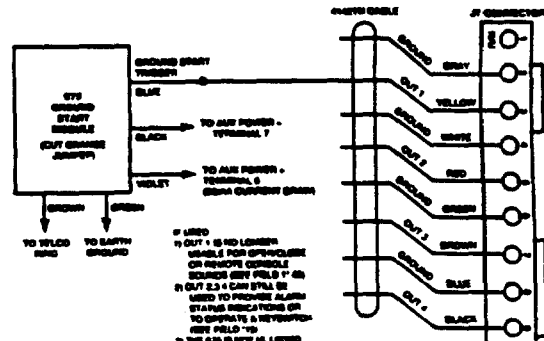

Figure 8. GROUND START MODULE

REMOTE KEYSWITCH

NOTE: 4146 Keyswitch is not UL approved.

If the keyswitch option is selected (field *15), the alarm trigger outputs are disabled.

An optional Remote Keyswitch can be used for remote arming and disarming of the system. Note that keyswitch arming may only be used in one partition. If used, program field *15 must be set to the desired partition to enable the keyswitch option, and the 4146 keyswitch's normally open momentary switch and LEDs must be connected to Zone 7 and to the J7 connector trigger outputs respectively. A 2k EOL resistor must be connected across the switch regardless of whether or not zones 2-8 are selected to use EOL resistors. See diagram below.

A momentary short across this zone will arm the system in the "AWAY" mode. If the short is held for more than 3 seconds, the system will arm in the "STAY" mode. (i.e. all zones designated as zone types 4 or 10 will be automatically bypassed). After the system has been armed, the next time zone 7 is shorted, the system will disarm.

An optional closed-circuit tamper switch (model 112) can be wired in series with zone 7, so that, if the switchplate is removed from the wall, the tamper will open, disabling keyswitch operation until the system is next disarmed from the console.

NOTE: Only one keyswitch with LEDs can be supported by the system's power supply.

NOTE: Open/close reporting for keyswitch is enabled in field *40, and the keyswitch reports as user 0.

LED Indications are defined as follows:

GREEN	RED	MEANING
OFF	OFF	DISARMED & NOT READY
ON	OFF	DISARMED & READY
OFF	ON STEADY	ARMED AWAY
OFF	SLOW FLASH	ARMED STAY
OFF	RAPID FLASH	ALARM MEMORY

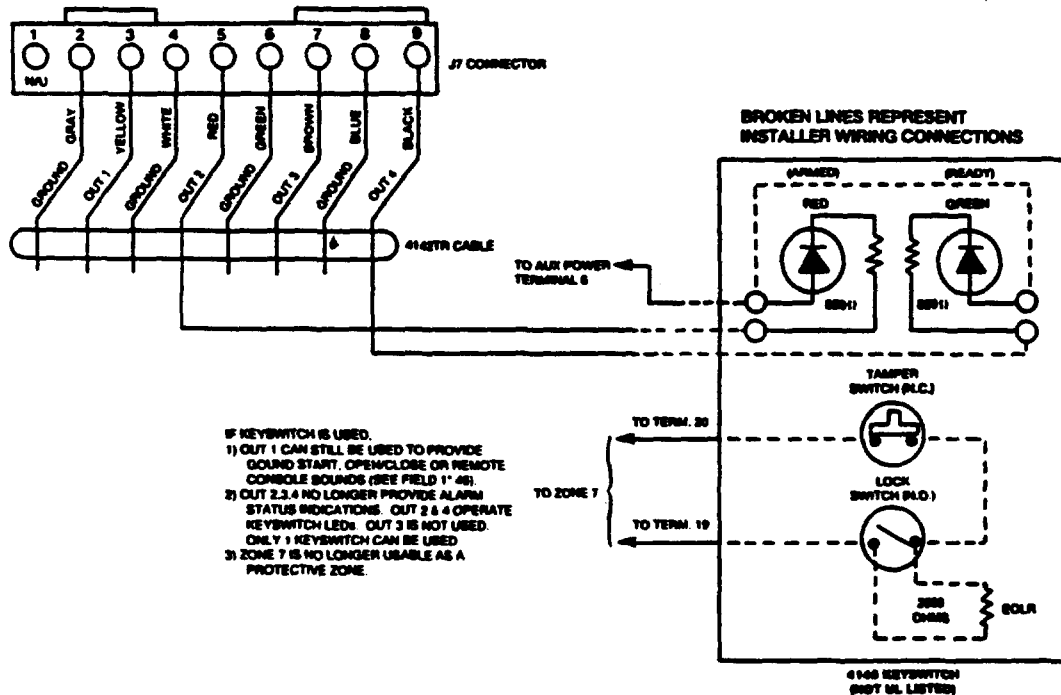

Figure 9. REMOTE KEYSWITCH WIRING

REMOTE CONSOLE SOUNDER OPERATION & WIRING

An optional Amseco PAL 328N can be used for installations where it is desired to remote the sounds produced by the console's built-in piezo sounder for one partition. The panel will remote all sounds (i.e. alarm, trouble, chime, entry/exit, etc.) produced by the console's built-in sounder except for the short clicks associated with console key depression. One application of this feature might be to produce chime sounds in a location which is distant from the panel's consoles. If used, program field 1*46 must be set to "2" to enable the remote console sounder option, and the Amseco piezo must be connected between the panel's auxiliary power and the J7 connector trigger output as shown below. In addition, field *15 must be used to select the partition whose console sounds are to trigger the sounder. Zone 7 must be assigned to be a keyswitch zone (even if keyswitch is not used).

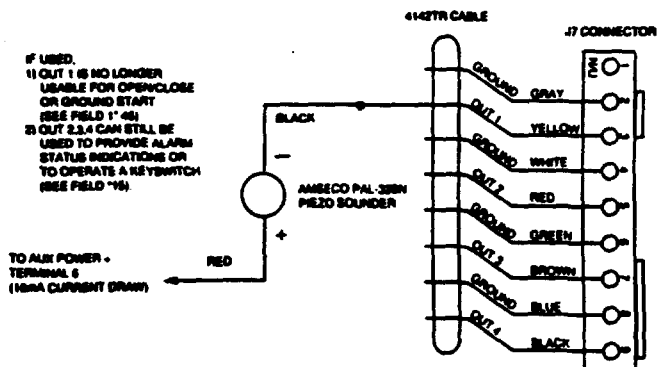

Figure 10. REMOTE CONSOLE SOUNDER WIRING

CONNECTOR J8 INPUTS & OUTPUTS (Event Logging Serial Printer/4100SM Direct Wire Downloading)

EVENT LOGGING PRINTER CONNECTIONS

Connector J8, located above connector J7 on the right side of the main PC board, is intended to be interfaced to a local serial printer via the 4100SM serial interface module, in applications where it is desired to print the event log on a local printer. Make connections between J8, the 4100SM module and the serial printer as shown below. Refer to the event logging section of this manual for a description of the console commands which initiate event log printing.

NOTE 1: Printer must be configured as follows:

- 8 data bits, no parity, 1 stop bit
- 300 or 1200 baud (1200 preferred)
- Hardware handshaking using DTR signal

NOTE 2: The 4100SM module is supplied with a 10 foot RS232 cable. A longer cable or an extension cable can be used if the 4140XMPT and serial printer are separated by more than 10 feet, but the total cable length should be less than 50 feet.

NOTE 3: Most printers either ignore the CTS, DSR and CD signals, or require them to be high (i.e. 3-15VDC as measured on RS232 DB25 connector pins 5, 6 & 8 respectively with respect to ground pin 7). The 4100SM module sets these pins high. If the printer being used will not operate with these pins high, then clip the blue (CTS), white (DSR) or red (CD) jumpers on the 4100SM module to set the corresponding signal floating. Important pins on the RS232C cable are pin 3 (data out), pin 7 (ground) and pin 20 (DTR ready).

NOTE 4: The DTR signal, as measured at 4100SM TB1, should be high (9.5-14VDC) when the printer is powered, properly connected, on-line and ready to print. This signal will be low (0-1.5VDC) when the printer is not powered, not properly connected, off-line or out of paper. The 4140XMPT will not send printing data to the printer unless the DTR signal is high.

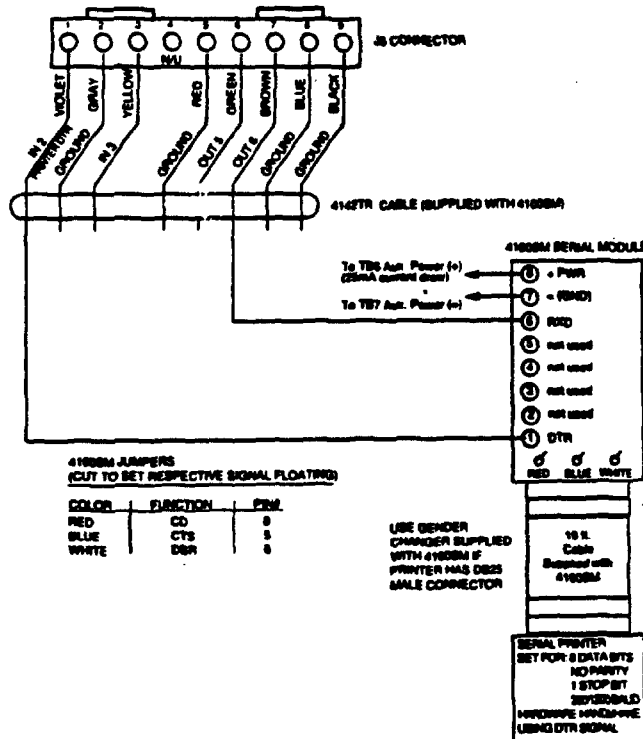

Figure 11. EVENT LOGGING PRINTER CONNECTIONS

DIRECT WIRE DOWNLOADING CONNECTIONS

The 4140XMPT can be downloaded without using a modem or telephone line by using 4100PC Downloading Software and a 4100SM Serial Module.

IMPORTANT: The connections between the 4140XMPT and the 4100SM are different than those shown in the 4100SM installation instructions. See diagram below for correct connections. In addition, when the "green" wire is referred to in step 2 of the IN CASE OF DIFFICULTY section of the 4100SM instructions, use the "violet" wire.

Connector J8, located above connector J7 on the right hand side of the main PC board, is intended to be interfaced to either a local serial printer (see EVENT LOGGING CONNECTIONS) or a computer terminal. Make connections to a computer terminal as shown below. Note that the violet wire connection for computer terminals differs from that used when connecting a serial printer.

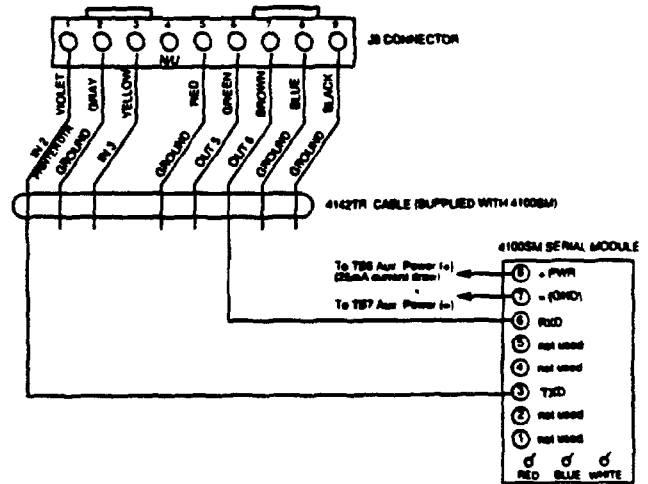

Figure 12. DIRECT WIRE DOWNLOAD CONNECTIONS

IV. MOUNTING AND POWERING THE SYSTEM

MOUNTING

MOUNTING THE 4140XMPT PC BOARD

Before mounting the circuit board, be certain that the appropriate metal knockouts have been removed. **DO NOT ATTEMPT TO REMOVE THE KNOCKOUTS AFTER THE CIRCUIT BOARD HAS BEEN INSTALLED.**

1. Hang the three mounting clips on the raised cabinet tabs. Observe proper clip orientation to avoid damage to the clip when mounting screws are tightened and to avoid problems with insertion and removal of the PC board.
2. Insert the top of the circuit board into the slots at the top of the cabinet. Make certain that the board rests in the slots as indicated in step 2 detail.
3. Swing the base of the board into the mounting clips and secure the board to the cabinet with the accompanying screws (as illustrated in step 3 detail).

ADVISORY

Make certain that the mounting screws are reasonably tight to insure that there is a good ground connection between the PC board and the cabinet. Also, dress field wiring away from the microprocessor (center) section of the PC board. The cabinet provides 2 loops on its left and right sidewalls for anchoring field wiring using tie wraps. These steps are important to minimizing the risk of panel RF interference with television reception.

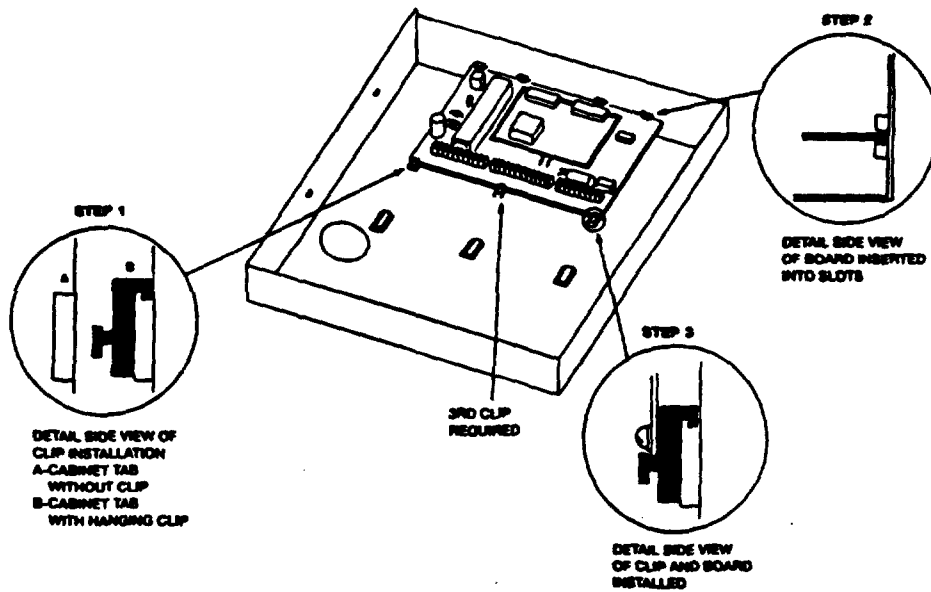

Figure 13. MOUNTING THE PC BOARD

MOUNTING THE CABINET LOCK

1. Remove the lock knockout on the control cabinet cover. Insert the key into the lock. Position the lock in the hole making certain that the latch will make contact with the latch bracket when the door is closed.
2. While holding the lock steady, insert the retainer clip into the retainer slots.

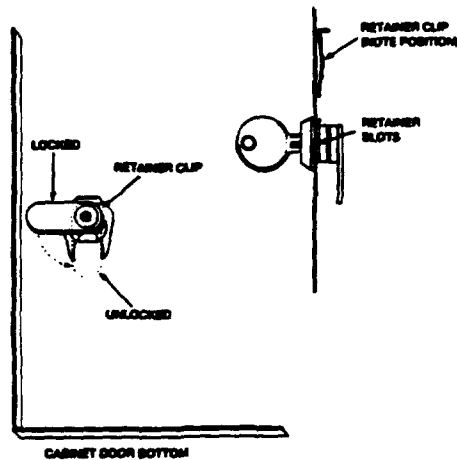

Figure 14. MOUNTING THE CABINET LOCK

POWERING THE SYSTEM

PRIMARY POWER

Power to the 4140XMPT control panel is supplied by model No. 1361* Plug-in Transformer which is rated at 16.5VAC, 40VA. Caution must be taken when wiring this transformer to the panel to guard against blowing the fuse inside the transformer (non-replaceable).

* NOTE: Use 1361CN Transformer in Canadian installations.

BACK-UP POWER

In the event of an AC power loss, the 4140XMPT control panel is supported by a back-up, rechargeable gel cell battery. YUASA NP4-12 (12V, 4AH) and NP7-12 (12V, 7AH) batteries are recommended. Do not use Gates batteries (sealed lead-acid type).

The standby battery is automatically tested every 24 hours, beginning 24 hours after exiting programming mode. In addition, entry into the test mode will cause a battery test to be initiated.

BATTERY STANDBY TABLE

4140XMPT AUX. STANDBY CURRENT DRAW				
AMP-HRS.	200mA	400mA	600mA	750mA
4.0*	6 hrs.	4 hrs.	3 hrs.	2.5 hrs.
6.0-7.0	11 hrs.	7 hrs.	5.5 hrs.	4 hrs.

NOTE: The above figures are approximate, and may vary depending upon the age, quality, and capacity of the battery at the time of the AC loss.

* Use 4AH battery for UL installations.

EARTH GROUND CONNECTIONS

In order for the lightning transient protective devices in this product to be effective, the designated earth ground terminal, must be terminated in a good earth ground. The following are examples of good earth grounds available at most installations:

Metal Cold Water Pipe: Use a non-corrosive metal strap (copper is recommended) firmly secured to the pipe to which the ground lead is electrically connected and secured.

AC Power Outlet Ground: Available from 3-prong, 120VAC, power outlets only. To test the integrity of the ground terminal, use a three-wire circuit tester with neon lamp indicators, such as the UL-Listed Ideal Model 61-035, or equivalent, available at most electrical supply stores.

POWER-UP PROCEDURE

1. Fill out the Polling Loop Current Draw and Auxiliary Device Current Draw Worksheets shown below. Make sure that the currents drawn from these outputs do not exceed their respective ratings.

CAUTION: Failure to observe the polling loop current rating will cause polling loop malfunction. Failure to observe the auxiliary output current rating will result in a battery which does not charge properly or possibly a tripped circuit breaker.

2. Wire the 1361 transformer (1361CN in Canada) to the panel (before connecting the battery) as shown in the SUMMARY OF CONNECTIONS diagram. Do not plug in at this time.

3. Connect all polling loop and auxiliary devices, such as consoles, PIRs, etc.

4. Plug the 1361 into an 24 hour, uninterrupted AC outlet. After a few seconds, the green POWER LED on the console(s) should light and the console(s) should display "DISARMED READY TO ARM."

5. Connect the battery as shown in the SUMMARY OF CONNECTIONS diagram.

POLLING LOOP CURRENT DRAW WORKSHEET

RPM DEVICE	CURRENT	# UNITS	TOTAL CURRENT
4194 Contact	1 mA		
4192SD Photo Smoke	0.4 mA		
4192SDT Smoke w/Heat	0.4 mA		
4192CP Ion Smoke	0.4 mA		
4275 Dual PIR	1 mA		
4278 Quad PIR	1 mA		
4190 2-Zone RPM	1 mA (LOW) 2 mA (HIGH)		
4208 8-Zone RPM	16 mA		
4280 63 Zone RF	40 mA		
4280-8 8 Zone RF	40 mA		
TOTAL **			

** If the total current draw exceeds 64 mA, a 4197 Loop Extender module must be used.

** If using two 4280s or 4280-8s, you can power one of them from auxiliary power instead of using a 4197 loop extender module.

AUXILIARY DEVICE CURRENT DRAW WORKSHEET

DEVICE	CURRENT	# UNITS	TOTAL CURRENT
5137AD Console	90 mA		
675 Ground Start Module	50 mA		
4280 or 4280-8 Receiver	40 mA†		
Built-in Polling Loop	(total poll loop worksht)		
4197 Poll Loop Extender	80 mA†		
•			
•			
•			
TOTAL			(750mA max)

* Using hard-wire devices such as PIRs, refer to the specifications for that particular unit's current draw.

† Only applies if powered from Control's auxiliary power.

V. SYSTEM OPERATION

SECURITY ACCESS CODES

GENERAL INFORMATION

The VISTA 4140XMPT System allows up to 128 (99 maximum per partition) security access codes to be assigned, each identified by a user ID number. In addition, the Quick Arm feature can also be programmed, which enables the [#] key to be pressed instead of entering the security code when arming the system. The code must still be entered when disarming the system. Note that Open/Close reporting of Quick Arm is enabled if User 2 is enabled for Open/Close reporting, and that Quick Arm reports as User 0.

USER CODES & LEVELS OF AUTHORITY

Each user of the system can be assigned various levels of authority (tells system what system functions that user is authorized to do), and can have different levels of authority within each partition. Use the "View Capabilities" keypad function to view the partitions and authority levels for which a particular user is authorized. In highest to lowest ranking, these levels are as follows:

Level	Title
0	Installer
1	Master
2	Manager
3	Operator level A
4	Operator level B
5	Operator level C
6	Duress

Installer (Level 0)

- Can perform all system functions (arm, disarm, bypass, etc.) and is the only user that can enter program mode.
- Enter program mode and make programming changes.
- Change his own code.
- Add, Delete, Change MASTER, MANAGER, or OPERATORS.
- Select open/close reports for any user.
- Operate a partition, but CANNOT DISARM if armed by a code other than INSTALLER's code (including Quick Arm).

Master (Level 1)

- May create other users of the system below this level (Master cannot assign anybody a level of 0 or 1).
- Change his own code.
- Add, Delete, Change MANAGERS or OPERATORS.
- Open/close reporting of added operator users will BE SAME as his own (enabled or disabled as assigned by INSTALLER).
- Operate a partition.

Manager (Level 2)

- Can perform all system functions (Arm, Disarm, Bypass, etc.) programmed by Master.
- May create other users of the system below this level (Manager cannot assign anybody a level of 0, 1, or 2).
- May change his own code.
- May Add, Delete, Change OPERATORS.
- Open/close reporting of added users will BE SAME as his own (enabled or disabled as assigned by INSTALLER or MASTER).
- May operate a partition.

Operator (Levels 3-5)

- Lowest levels of users.
- May operate a partition with one of the three OPERATOR authority levels A through C listed in the OPERATOR's CODE paragraph later in this section.

Duress (Level 6)

- Can arm and disarm the system, but also sends silent duress message to central station (if service is connected).
- Code is assigned on a partition by partition basis.

General Rules on Authority Levels and changes
To keep this structure manageable, the following rules apply to users when making modifications within the system based on the user code authority levels:

- A user may not delete or change the user code of the SAME or HIGHER authority than which he is assigned.
- A user may only ADD users to a LOWER authority level.
- A user may assign other users access to other partitions only if he himself has access to those partitions.
- A user can only be DELETED or CHANGED from within the partition he is assigned.

MULTIPLE PARTITION ACCESS (GOTO Function)

To make a partitioned environment particularly useful, the system must allow for certain people to have access to other partitions. This is particularly true in the Factory/Office environment where the president of the company wants access to any area of his company. The 4140XMPT has total flexibility in supporting this requirement. On a USER basis, each user is programmed for a base partition (the one he normally is assigned) and one or more partitions which he can be authorized to access.

In addition, within each partition, each USER may be programmed to have different levels of authority. For example, User #3, the V.P. of Engineering, could be assigned to work within the Engineering Department (Partition 1) of ABC Manufacturing. Since he needs the full capabilities in his area, he is assigned as a MASTER with Level 1 authority. This means he may Arm, Disarm, Bypass, Add or Modify users in partition 1. It is also a requirement that he be able to gain access to the manufacturing area (partition 2) on an emergency basis. You can set this up easily with the 4140XMPT by now requesting that he also be assigned to partition 2, with a level of authority set lower, such as Level 4 (OPERATOR Level B) which allows him to Arm and Disarm, but nothing else. The control will automatically assign him the next available user number within partition 2 and does not require reprogramming of his already existing 4 digit security code! This type of setup can be done for each user of the system and for any combination of up to 8 partitions!

EXAMPLE OF MULTIPLE PARTITION ACCESS

Part 1	Part 2	Part 3	Part 4	Part 5	Part 6	Part 7	Part 8
User 3	User 5						
Level 1	Level 4						
Master	Oper B						

In the above example, User 3 has MASTER authority in partition 1 and OPERATOR B authority in partition 2. His user number in partition 2 is User 5 and his 4 digit code is the same for both partitions. Access to Other Partitions. Note that if a user number is already being used in a partition, the system will automatically assign an unused User number.

Assigning users to other partitions is one thing, but how about actually being a user and trying to "see" one of the other partitions? The 4140XMPT has developed a simple key sequence (code + [#] + partition number 0-8, partition 0 returns to the default partition for that console) scheme for a user to go to another partition.

Once there, the current display becomes attached to that partition and status requests, etc are now displayed for that partition, unless a period of 90 seconds elapses with no key entries. To return to your original partition, you may enter the same key sequence and end it with your normal partition number or "0". You're now back to where you started. It's that simple! You may view this operation as a big selector switch and you are at the switch at the console.

INSTALLER CODE (User #1/Authority Level 0)

The installer programs an Installer's Code initially as part of the programming procedure, and this code is the only code that permits re-entry into the programming mode (unless *98 has been previously used to exit the programming mode, see below). The Installer's Code can also be used to perform normal system functions.

The system also provides an Installer Code lock-out feature, which prevents the use of the Installer's Code from re-accessing the Programming mode after the initial programming. This feature is activated by pressing *98 to exit Programming mode. The only way to access Programming mode once this feature is activated, is by powering down the system and powering up again, and then pressing both the * and # keys at the same time within 30 seconds of power up. If re-access to Programming mode using the Installer's Code is desired after initial programming, then exit Programming mode by pressing *99. For additional security, the installer code can be used to disarm the system only if it was used to arm the system.

The installer also programs the master security codes, which are the codes intended for use by the primary users of the system. The master codes can then be used to assign up to 99 lower level codes, which can be used by other users of the system who don't have a need to know the master code.

Note that Open/Close reporting for the installer code is enabled in field *39.

As shipped from the factory, the initial installer's code is pre-programmed (default = 4-1-4-0), and can be changed by the installer to any code desired (programming field *00).

User numbers must be entered as 2-digit entries. Single digit user numbers must, therefore, always be preceded by a "0" (example, 03, 04, 05, etc.). Make sure the end user understands this requirement. Temporary codes are entered as 4-digit numbers.

IMPORTANT!: Unless Ademco Contact ID reporting is used, only user codes #1 - #15 can uniquely report to the central station using the communication formats provided. Users #16 - #99 will report as User #15, if enabled for open/close reporting, for the other reporting formats.

IMPORTANT!: During user code entry, normal key depressions at other consoles in a partition will be ignored. However, panic key depression will cause an alarm and terminate user entry.

OPEN/CLOSE REPORTING NOTE: When adding a user, the system will only prompt for Open/Close report capability if the user is being added by the installer. When a Master or Manager adds a new user, the new user's Open/Close reporting enable will be the same as that of the Master or Manager adding the user. If Open/Close reports are required to be selectable by the Master or Manager, the installer should assign two Master or Manager user codes: one with Open/Close reporting enabled, and one without Open/Close reporting.

EXAMPLE: User may be regularly assigned to partition 1. This would be the default display for this user, however he may "select" to go to partition 2 for example. (Assumes he has been programmed for access to partition 2) The user enters his normal access code and the proper sequence to select another partition followed by the number 2 for partition 2. The display will now select partition 2 information for view and further action. In the above example notice that no access is allowed for this user into partitions 3 - 8. Attempts to access these partitions would be denied automatically.

To **ADD** a Master, Manager or Operator code:
Enter Installer Code + [8] + new User # + new User's code

Console will prompt for Authority level. Enter the level number as follows:

- 1 = Master (Arm, Disarm, Bypass, add or modify lower level users)
- 2 = Manager (Arm, Disarm, Bypass, add or modify lower level users)
- 3 = Operator Level A (Arm, Disarm, Bypass)
- 4 = Operator Level B (Arm, Disarm)
- 5 = Operator Level C (Arm, Disarm only if system armed with this code)
- 6 = Duress (Arm, Disarm, triggers silent panic alarm)

Console will then prompt for Open/Close reporting option[†]. Press 0 (NO) or 1 (YES). Console will also prompt for authority of this user to access other partitions. Press 0 (NO) or 1 (YES). If yes, the next partition number in sequence will be displayed with a prompt asking if access is desired. Press 0 (NO) or 1 (YES). If no, the next partition number will be displayed with the "access desired" prompt. If yes, the system will automatically assign a user number and will prompt for the authority level this user should have in the assigned partition. Enter the desired authority level number. The next partition number will then be displayed with a prompt for access. When all partitions have been displayed, the console will scroll through all partitions to which access has been assigned, and will display the user number and authority level for each.

To **CHANGE** a Master, Manager or Operator code:
Enter Installer code + [8] + User number + new code for that user

The system will detect that the user number is already assigned and will prompt if this is a new user. Press 0 (NO). The system will then confirm that the change is allowed based on authorization level. If the user number is the same as the Installer's, the system will prompt for the new code to be reentered. This prevents accidentally changing a high level code.

To **DELETE** a Master, Manager or Operator code:
Enter Installer code + [8] + User number + Installer code

The system will prompt if this code should be deleted. Press 0 (NO) or 1 (YES). If yes, that user's code will be removed from all partitions to which it had been assigned, and all authorization levels and other information about that user will be deleted..Note that a user can only be deleted from the partition in which it was first assigned, and can only be deleted by a user with a higher authority level. A user cannot delete himself.

TO EXIT THE USER CODE ENTRY MODE, either press [*] or [#], or don't press any key for 10 seconds.

MASTER/MANAGER CODES (Authority Levels 1/2)

The Master Code is the code intended for use by the primary users of the system when performing system functions, and can be changed by the Master User. The factory default master code is 1-2-3-4. For additional security, the Master Code can be used to assign lower level codes (maximum of 99 per partition), which can be used by secondary users of the system who do not have a need to know the Master Code (supervisors, employees, cleaning personnel, tenants, etc.). Each user's code can be individually eliminated or changed at any time.

OPEN/CLOSE REPORTING: Note that open/close reporting enables for added users are the same as that of the master or manager adding the new user.

Master Codes and all lower level codes can be used interchangeably when performing system functions within a partition (a system armed with a user's temporary code can be disarmed with the Master Code or another user's temporary code), with the exception of the Operator Level C Code described later in this section.

To add, change or delete a Manager or Operator code, follow the same procedures described in the INSTALLER CODE paragraph, substituting Master or Manager code for Installer code. Note that a MANAGER cannot delete, change or add another MANAGER.

OPERATOR CODES (Authority Levels 3-5)

Operators can arm and disarm the system to the authority assigned, but cannot add or modify any user. The table below lists the three authority levels. If Operator Level C is selected (sometimes known as Babysitter code), that operator's code cannot be used to disarm the system unless the system was armed with that code. This code is usually assigned to persons who may have the need to arm and disarm the system at specific times only (ex. a babysitter needs to control the system only when babysitting).

OPERATOR LEVELS OF AUTHORITY

Level	Title	Functions Permitted
3	Operator Level A	Arm, Disarm, Bypass
4	Operator Level B	Arm, Disarm
5	Operator Level C	Arm, Disarm only if armed with same code

DURESS CODE (Authority Level 6)

The duress code is a means of sending a silent alarm to a central monitoring station if the user is being forced to disarm (or arm) the system under threat. This feature is only useful if the system is connected to a central station. When the system's Auxiliary Voltage Triggers are connected to another communication's media (Derived Channel/Long Range Radio), note that duress is signalled on the same trigger that signals silent panic (whereas duress has its own unique report when digitally communicated).

The duress code is assigned on a partition by partition basis and can be any code desired. When used, the system will disarm (or arm), but will also send a silent alarm to the central station. There will be no indication at the console that an alarm was sent.

SETTING THE REAL-TIME CLOCK

PROCEDURE

NOTE: A 5137AD console must be used to set the real-time clock, or the clock can be set via the Downloader software.

To enter real-time clock mode, press CODE + #63. The display will show:

```
TIME/DATE - ? ON
12:01 AM 01/01/90
```

The "?" indicates the current mode. The [6] key changes the mode from DAY to HOUR to MINUTE to MONTH to DATE to YEAR. The [4] key changes the mode in reverse order.

The [3] & [1] keys are used to set the TIME/DATE values. The [3] key moves the TIME/DATE ahead, the [1] key moves the TIME/DATE backward.

To set the day, use the [3] or [1] key to change from ? ON to MON to TUE, etc.

To set the time, press [6] until the "?" appears in the hours position, then use the [3] or [1] key to set the hour. Press [6] again and use the [3] or [1] key to set the minutes. Use the [7] key to set AM or PM.

To set the date, press the [6] key until the "?" appears in the month position, then use the [3] or [1] key to set the month. Press the [6] key again and use the [3] or [1] key to set the date. Press the [6] key again and use the [3] or [1] key to set to set the year.

To exit clock mode, press either the [8] key or the [-] key. Exiting with the [8] key will save all changes. Exiting with the [-] key will exit without changing any of the values (used when viewing the time settings, but no changes are desired).

257

KEYPAD FUNCTIONS

GENERAL INFORMATION

Note that if QUICK ARM is enabled (field "29), the [#] key can be pressed instead of entering the security code, for any of the arming procedures (Away, Stay, Instant, Maximum, etc.).

The keypad allows the user to arm and disarm the system, and perform other system functions, such as bypassing zones, view messages from the central station and display zone descriptors. Zone and system conditions (alarm, trouble, bypass) are displayed in the Display Window.

When an alarm occurs, console sounding and external sounding will occur, and the zone(s) in alarm will be displayed on the console. Pressing any key will silence the console sounder for 10 seconds. Disarming the system will silence both console and external sounders. When the system is disarmed, any zones that were in an alarm condition during the armed period will be displayed (memory of alarm). To clear this display, simply repeat the disarm sequence (enter the security code and press the OFF key).

The consoles also feature chime annunciation, and 3 panic key pairs (for silent, audible, fire or personal emergency alarms) which can notify the central station of an alarm condition, if that service is connected.

ARMING FUNCTIONS

The following is a brief list of system commands. For detailed information concerning system functions, refer to the User's Manual.

- Disarmed Not Ready** Before arming, the system must be in the READY condition (all zones must be intact). If the "NOT READY" message appears, press the READY ["] key to display faulted zones.
- Arming Away** Enter code + AWAY [2].
Arming Stay Enter code + STAY [3].
Arming Instant Enter code + INSTANT [7].
Arming Maximum Enter code + MAXIMUM [4].

SUMMARY OF ARMING MODES

Mode	Features For Each Arming Mode			
	Exit Delay	Entry Delay	Perimeter Armed	Interior Armed
AWAY	Yes	Yes	Yes	Yes
STAY	Yes	Yes	Yes	No
INSTANT	Yes	No	Yes	No
MAXIMUM	Yes	No	Yes	Yes

- Disarming** Enter code + OFF [1].
Bypassing Zones Enter code + BYPASS [6] + zone number. To automatically bypass all faulted zones, use "Quick Bypass" method: Enter code + BYPASS + [#].
- Chime Mode** Enter code + CHIME [9]. To turn chime mode off, enter code + CHIME again.

PARTITION "GOTO" COMMANDS(5137AD only)

Each console is assigned a default partition for display purposes, and will show only that partition's information. To see information for another partition, or perform system functions in another partition, use the GOTO command (code + ["] +partition number 0-8). The console will remain in the new partition until directed to go to another partition, or until 90 seconds has elapsed with no keypad activity.

VIEW CAPABILITIES OF A USER (5137AD only)

The console will display the partitions that user is authorized for, the user number, and the authority level for all partitions authorized. Enter code + [*] + [#]. The user's capabilities in each authorized partition will typically be displayed as follows:

Part. 1 WHSE
User 01 Auth.=1.

The user's Open/Close report capability is shown by the dot following the authority level. If Open/Close is not enabled for a user, the dot will not appear.

VIEWING DOWNLOADED MESSAGES (5137AD only)

Users may occasionally receive messages on the console display from their installation company. When this occurs, the console will display "Message. Press 0 for 5 secs.". Instruct the user to press and hold the 0 key to display the central station's message. Note that the system must be in the READY state to view these messages.

USING THE BUILT-IN USER'S MANUAL(5137AD only)

An abbreviated User's Manual is stored in the system's memory, and can be particularly useful to the end user if the printed User's Manual is not conveniently accessible when the user needs to perform a seldom used and unfamiliar system procedure. The Built-in User's Guide is displayed by simply pressing any of the function keys (e.g., OFF, AWAY, STAY, MAXIMUM, BYPASS, INSTANT, CODE, TEST, READY, #, and CHIME) for approximately 5 seconds and then releasing it. Abbreviated instructions relative to the key that has been pressed will then be displayed (2 lines of text are displayed at a time). This function operates in either the armed or the disarmed state.

DISPLAYING DESCRIPTORS (5137AD only)

The Alpha Consoles can display all programmed descriptors, which is useful to the installer when checking entries, and can be helpful to the user when there is a need to identify zones. To display descriptors, press and hold the READY key until the built-in instructions for that key appear, then release the key. The zone descriptors will appear one at a time, for about 2-3 seconds each. For faster viewing, press the READY key to display the next descriptor in numerical order and so on. When all descriptors have been displayed, the Control will exit display mode. To exit display mode before all descriptors have been displayed, enter the security code and press the OFF key.

PANIC KEYS

There are three pairs of keys ([* + 1], [# + 3], [* + #]) that, if programmed, can be used to manually initiate alarms and send a report to the central station. Each pair of keys can be individually programmed for 24 Hour Silent, Audible or Auxiliary (Emergency) responses. The panic function is activated when the appropriate pair of keys are pressed at the same time.

The panic functions are identified by the system as follows:

PANIC PAIR	Displayed as Zone
* + 1	95
# + 3	96
* + #	99

For 5137AD consoles, these panic keys can also be programmed with an alpha descriptor.

IMPORTANT: For the Panic functions to be of practical value, the system must be connected to a central station.

TROUBLE CONDITIONS

GENERAL INFORMATION

The word "CHECK" on the Console's display, accompanied by a rapid "beeping" at the Console, indicates that there is a trouble condition in the system. The audible warning sound can be silenced by pressing any key. Instruct users to call for service immediately upon seeing any of the following messages.

"CHECK" MESSAGES

- A display of "CHECK" accompanied by a display of one or more zone descriptor(s) indicates that a problem exists with those zone(s). First, determine if the zone(s) displayed are intact and make them so if they are not. If the problem has been corrected, key an OFF sequence (Code plus OFF) to clear the display.
- A display of the word "CHECK" accompanied by a numeric display of "97" indicates that a short exists on the Polling Loop and may eliminate some of the protection. Fault "97" can be assigned an alpha descriptor when using the 5137AD console.
- A display of the word "CHECK" accompanied by a numeric display of "88", "89", "90", or "91" indicates a 4280 Receiver problem. Faults "88", "89", "90" & "91" can be assigned alpha descriptors when using the 5137AD console.

OTHER TROUBLE CONDITIONS

- A display of "COMM. FAILURE" at the Console indicates that a failure occurred in the telephone communication portion of your system.
- A display of "LO BAT" and a zone descriptor, accompanied by a once per minute beep at the Console indicates that a low battery condition exists in the wireless transmitter displayed. The audible warning sound may be silenced by pressing any key. A display of "SYSTEM LO BAT" indicates that a low battery condition exists with the system's backup battery.
- A display of "4280 SET UP ERROR" at the console indicates that a 4280-8 receiver is being used in a system with more than 8 RF zones programmed. If this is not corrected, none of the zones in the system will be protected. If more than 8 RF zones are desired, a 4280 Receiver must be used.

POWER FAILURE

If the POWER indicator is off, and the message "AC LOSS" is displayed, the Console is operating on battery power only. Check to see that your system's plug-in transformer has not been accidentally pulled out. Instruct the user to call a service representative immediately if AC power cannot be restored.

EVENT LOGGING PROCEDURES

IMPORTANT: In order for time and date stamping to occur, the system's real-time clock must be set. Refer to the **SETTING THE REAL TIME CLOCK** section for details.

GENERAL INFORMATION

The system has the ability to record various events in a history log (224 event capacity) wherein each event is recorded in one of five categories (alarm, check, bypass, open & system), with the time and date of its occurrence (if real-time clock is set). The log may be viewed (Display Mode) using a 5137AD alpha console, or can be printed (Print Mode) on a serial printer (connected to the system via a 4100SM Serial Module; see **CONNECTOR J8 INPUTS & OUTPUTS** section for connection details).

EVENT LOG MODE COMMANDS

Display Mode: Enter CODE + [#] + [6] + [0]
Print Mode: Enter CODE + [#] + [6] + [1]
Clear Event Log: Enter CODE + [#] + [6] + [2]
To EXIT Event Log Mode: Press [*] at any time.

PROGRAMMING

The system can be configured for the following event log activities:

- To either record events but not print them unless commanded to do so, or to automatically print the events as they occur (field 1*72).
- Specific categories of events to be logged can be selectively enabled (field 1*70).
- The time stamp can be programmed for either 12 or 24 hour formats (field 1*71).
- The printer baud rate can be set to either 300 or 1200 baud (field 1*73).
- Set event log time/date report enable (fields 1*40 & 1*41).
- Enable reporting of event log capacity (ie. 50% full, 90% full & overflow) programmed in fields 1*40 & 1*41.

EVENT LOGGING DISPLAY & PRINT MODES

After entering either mode, the following will be displayed:

ENTER 0= RECENT
1= COMPLETE

The Event Log holds up to 224 events, and can display or print all events in a category (complete), or only those events in a category occurring since the last Clear Event Log command (recent). Note that once the Event Log is full, the oldest event will be erased upon the logging of any new event. Press the desired display mode key, 0 or 1.

SCAN LOG BY PART
0=NO 1-8=PART #

The system allows viewing of any partition's event log. Enter the partition number for the partition whose events are to be displayed. Entering 0 (NO) will display all partition's events.

For display and printing purposes, events are stored on a partition by partition basis (except system events), and are grouped into five categories as follows.

Use the [3] & [1] keys to scroll to the next or previous category screens respectively:

ALARM EVENT LOG
TYPE CCC UUU

Displays time/date for zones that have either caused an alarm or have been restored in selected partition.

CHECK EVENT LOG
TYPE CCC UUU

Displays time/date for zones that have caused a trouble or supervisory condition in selected partition.

BYPASS EVENT LOG
TYPE CCC UUU

Displays time/date for zones that have been bypassed in selected partition.

OP/CL EVENT LOG
TYPE CCC UUU

Displays time, date and user number for each arming and disarming of the system for the partition selected.

SYSTEM EVENT LOG
TYPE CCC UUU

Displays time/date for system problems, such as AC Loss, communication failure, etc., regardless of partition.

ALL EVENT LOG
TYPE CCC UUU

Displays all categories of events in chronological order, from most recent to oldest.

To display the events in a particular category, press [8] at the desired category screen. If in Display Mode, events will appear one at a time from the most recent to the oldest. Press [8] again to display each subsequent event. If in Print Mode, the first press of [8] will cause the printer to print all events in that category, with each event automatically scrolled on the display console. The following is a typical display:

P8 01/01 12:02AM
BURGLARY C03

Shows burglary alarm occurred in zone 3 of partition 8, at 12:02AM on January 1.

After the last event in the selected category has been displayed, the following will appear for a few seconds:

END OF EVENT LOG
TYPE CCC UUU

The system will automatically return to the RECENT/COMPLETE selection screen described earlier.

CLEAR EVENT LOG

To clear the Event Log, enter CODE + [#] + [6] + [2]

The following will appear:

CLEAR EVENT LOG
0=NO 1=YES

Press [1] if Event Log is to be cleared from memory. All events in the log will still be displayed if the FULL LOG DUMP option is selected. Only those events occurring from the time of the CLEAR command will be displayed if PARTIAL display option is selected. Press [0] if event log is not to be cleared at this time.

If [1] is pressed, the following will appear:

ARE YOU SURE?
0=NO 1=YES

Press [1] if it is desired to clear the event log. Press [0] if event log is not to be cleared.

SCREEN DEFINITIONS

RECENT	Events since last CLEAR
COMPLETE	Displays all events
TYPE	Type of event (Burg., Fire, etc.)
CCC	Zone (contact) number
UUU	User number

VI. SYSTEM COMMUNICATION

SPLIT/DUAL REPORTING

Dual reporting (*51) sends all reports to both primary and secondary phone numbers. Split reporting allows reports to be divided between the phone numbers according to the field's (1*34) selections. Split/Dual reporting can be selected by enabling dual reporting and enabling one of the split reporting options in field 1*34. If option [1] is selected, all alarms, alarm restores and cancel reports will go to both phone numbers, while all other reports will go to the secondary phone number. If [2] is selected, open/close and test messages will go to both phone numbers, while all other reports will go to the primary phone number. Following are the Split/Dual Reporting options:

REPORTING FORMAT	FIELD NUMBER	
	*51	1*34
DUAL	1	0
SPLIT	0	1 or 2
SPLIT/DUAL	1	1 or 2

ADEMCO LOW SPEED

ADEMCO LOW SPEED is a pulsed format which responds to a 1400 Hz handshake and kiss-off, and transmits data with 1900Hz pulse tones @ 10 pulses per second (pps). A typical message consists of two rounds which must be verified by the receiver. A complete standard report consists of either a 3 or 4-digit account number followed by a 1-digit alarm code. Though 2 rounds are sent, only the valid report is displayed.

In expanded reporting, two messages are sent, two rounds per message, the first being the account number and alarm code, the second being the zone ID code to which the alarm was assigned. A complete expanded report consists of a 3 or 4-digit account number followed by a 1-digit alarm code, then the alarm code is repeated, followed by the channel number.

EX. Standard: CCCC E where: CCCC = account number
 Expanded: CCCC E E = event code
 EEEE Z Z = zone ID code

SESCOAR/RADIONICS

Standard and expanded reporting in the SESCOAR/RADIONICS format is virtually the same as ADEMCO Low Speed except for the following:

1. The handshake and kiss-off frequency is 2300 Hz.
2. The data is transmitted with 1800 Hz pulse tones.
3. The rate of transmission is 20 pps.

4+2 REPORTING

A 4+2 report consists of a 4-digit account number and a 2-digit alarm code, or event code. 4+2 reports can be accomplished either in ADEMCO Low Speed (10 pps), or SESCOAR/RADIONICS (20 pps) format.

In 4+2 reporting a unique 2-digit code for each zone is reported. A 4-digit account number followed by a 2-digit code is sent, where the first digit is the actual event, such as in ALARM, RESTORE, or TROUBLE, etc., and the second digit of the code represents the "zone" where the event occurred. (but not necessarily the actual zone number). Each code in itself is unique to a specific zone. If desired, the actual zone number can be reported by entering the corresponding 2-digit zone number (ex. zone 1= [0] [1]; zone 63= [6] [3]). A report might appear as:

1 2 3 4 5 9 (*5 or * might be a unique "TROUBLE RESTORE, ZONE 25).

4+2 EXPRESS

ADEMCO's new Express format provides the same information as the 4+2 format, but with three differences:

1. The data is transmitted in DTMF (Dual Tone Multi-Frequency, known as "TouchTone", at the rate of 10 characters per second). This greatly decreases the time it takes a report to go through to central station. An average 4+2 Low Speed report might take as long as 20 seconds to complete its report, but 4+2 Express takes under 3 secs.

2. Two message rounds are eliminated by the use of a checksum digit. Instead of the communicator sending 2 rounds per report, it sends only 1 round with a checksum digit at the end. Doing this also helps in decreasing the time it takes for a report to be sent.

3. The handshake frequency is 1400 Hz followed by 2300 Hz, and the kiss-off frequency is 1400 Hz.

ADEMCO HIGH SPEED REPORTING

ADEMCO's High Speed format transmits data in DTMF at a rate of 10 characters per second. The handshake frequency is 1400 Hz followed by 2300 Hz, and the kiss-off frequency is 1400 Hz. The message contains 13 digits as follows: A 4-digit account number + eight channels of zone information (1-8 or duress plus 9-15) + one status channel, which identifies the type of events being reported in the eight zone locations. A typical High Speed report will be kissed off in under 5 seconds. Channels 1 through 8 could have one of the following conditions:

- 1 = NEW EVENT
- 2 = OPENING (Status Channel Always = 2)*
- 3 = RESTORE
- 4 = CLOSING (Status Channel Always = 4)*
- 5 = NORMAL, NO EVENT TO REPORT
- 6 = PREVIOUSLY REPORTED, NOT YET RESTORED

* NOTE: Channel 1 will contain the user ID 1-9, A-F if Open/Close reporting is enabled.

The status channel might have one of the following conditions:

- 1 = DURESS (For Duress Plus Channels 9-15 Only)
- 2 = OPENING
- 3 = BYPASS (For Channels 1-8 Only)
- 4 = CLOSING
- 5 = TROUBLE (For Channels 1-8 Only)
- 6 = SYSTEM STATUS:
 - AC LOSS in Channel 1
 - LOW BATTERY in Channel 2
 - PROGRAM TAMPER in Channel 3
 - POWER ON RESET in Channel 4
- 7 = NORMAL ALARM STATUS (Chns 1-8 Only)
- 9 = TEST REPORT

A typical high speed report may look as follows:

1234 5115 5555 7 (Acct #1234 with alarms on channels 2 and 3)

LIMITATIONS

1. When using Ademco high speed, remember there are only 15 channels available, plus a duress channel. If more than 15 zones are being used, they will have to share channels.
2. With Ademco High Speed reporting, channels 9-15 cannot report troubles or bypasses. Use these channels for zones that will not report these conditions.

CONTACT ID REPORTING

This is the only format that can identify all 64 protection zones by their unique zone (Contact) ID numbers, and provides a 1-digit event qualifier and 3-digit, specifically defined event code, which quickly identifies the condition being reported.

Contact ID reports in DTMF (Dual Tone Multi-Frequency @ 10 characters per second) and responds to a 1400 Hz followed by 2300 Hz handshake, and a 1400 Hz kiss-off. This format also uses checksum instead of two message verification. A complete report takes under 3 seconds.

Contact ID Reporting takes the format: CCCC Q EEE GG ZZZ where:

- CCCC = Customer (subscriber) number.
- Q = Event qualifier, where: E=new event (1) and R= restore (3)
- EEE = Event code (3 hexadecimal digits), defined in the table on the next page.
- GG = Partition number.
- ZZZ = Zone/contact ID number reporting the alarm (001-099), or user number (001-070) for open/close reports. System status messages (AC Loss, Walk Test, etc.) contain zeroes in the ZZZ location.

261

TABLE OF CONTACT ID EVENT CODES

Code	Definition
110	Fire Alarm
121	Duress
122	Silent Panic
123	Audible Panic
131	Perimeter Burglary
132	Interior Burglary
133	24 Hour Burglary
134	Entry/Exit Burglary
135	Day/Night Burglary
142	Polling Loop Short Alarm
143	RF Receiver Failure-Alarm
150	24 Hour Auxiliary
301	AC Loss
302	Low System Battery
305	System Reset
306	Program Tamper
309	Battery Test Fail
332	Poll Loop Short-Trouble
333	RF Receiver Failure-Trouble
373	Fire Loop Trouble
380	Trouble (global)

Code	Definition
381	Loss of Supervision - RF
382	Loss of RPM Supervision
383	RPM Sensor Tamper
384	RF Transmitter Low Battery
401	O/C By User
403	Power-Up Armed
406	Cancel by User
407	Remote Arm/Disarm (Download)
408	Quick Arm
409	Keyswitch O/C
411	Call back Requested
441	Armed STAY
570	Bypass
601	Manually Triggered Test
602	Periodic Test
621	Event Log Reset
622	Event Log 50% Full
623	Event Log 90% Full
624	Event Log Overflow
625	Time/Date Reset

ADVISORY: Ademco's new Contact ID reporting is capable of uniquely reporting all 64 zones of information, as well as openings and closings for all 128 users, to central stations equipped with the Ademco 685 receiver using software level 4.5 or higher. 685 software levels below 4.5 cannot support Contact ID reporting. For information regarding updating the 685 receiver, contact Ademco's Technical Support group at 1-800-645-7492 (NY) or 1-800-458-9469 (CA).

4140XMPT COMMUNICATION PROGRAMMING GUIDE

Field #	Low Speed	Contact ID	High Speed	Express
*46, *48	Choose transmission speed and frequency	No effect	No effect	No effect
*52, *53	Send as either 4+2 or expanded	No effect	No effect	No effect
*79, *80	Enables alarm restores	Enables alarm restores	Enables alarm restores	Enables alarm restores
*49	Add checksum digit	No effect	Add checksum digit	No effect
*81, *82	Define codes and selects 4+1 or 4+2	1st digit enables report if it is non-zero	1st digit enables report if it is non-zero	Define codes and selects 4+1 or 4+2
*54, *56, *59, *61, *64, *66, *69, *71, *74, *76	Defines alarm event code	Enables reports	Assigns reporting chnl for all reports from this zone. Enables alarm reporting	Defines alarm event code
*55, *57, *60, *62, *65, *67, *70, *72, *75, *77	Defines code and selects 4+1 or 4+2	No effect	No effect	Defines code and selects 4+1 or 4+2
*58, *63, *68, *73, *78	Enables report and selects code. Note: No restores if event not sent.	Enables report	Enables report Note: Alarm channel must be programmed. (01-15)	Enables report and selects 1st digit of the 2-digit event code. NOTE: No restores if event not sent.
*50	Sescos/Radionics; Selects fixed digit time instead of fixed interdigit.	No effect	No effect	No effect
NOTES	Note: Low Speed will not send 3+2 messages. Zone ID digit is suppressed.	Note: If Contact ID is desired, it must be used on both primary & secondary phone #'s.	If High Speed is used for secondary, it must be used for primary. If used on primary, any other format can be used on secondary.	

VII. PROGRAMMING THE SYSTEM

GENERAL PROGRAMMING PROCEDURES

GENERAL INFORMATION

Review the global and specific partitioning features listed in the GENERAL INFORMATION section of this manual before programming.

The system is shipped with a set of pre-programmed values that are designed to meet the needs of many installations. These can be changed by the installer to suit specific needs if desired. In addition, four sets of pre-programmed communication default values can also be loaded by the installer, each set designed for a specific communication format. These too can be changed to suit the needs of a particular installation.

Changes to these pre-programmed values can be programmed directly from the console (5137AD only) or from an IBM compatible computer terminal either remotely (using a HAYES 1200 SMARTMODEM) or at the job site (using the 4100SM Serial Module). Both methods use the 4130PC Downloading software (be sure that the software version used includes a 4140XMPT menu selection). See the DOWNLOADING section for more information.

For alpha consoles, English Language descriptions of the zones and a custom installer message (which appears when the system is ready to arm) can be programmed using the built-in vocabulary of words (see #93 MENU MODE, ALPHA PROGRAMMING paragraphs later in this section).

USER-FRIENDLY ZONE, DEVICE & ALPHA PROGRAMMING (#93 Menu Mode)

To help set up a partitioned environment quickly and accurately, Ademco has provided a tremendous aid to the programming process. Instead of the traditional method of programming all the fields associated with zones and the partitions they are associated with, you may now logically program a zone for all its characteristics as prompted by the 4140XMPT (refer to the #93 MENU MODE section for details). This ensures that you assign each zone to a partition and that a zone response type has been assigned.

This user-friendly scheme for programming eliminates the possibility of you forgetting to enter a field properly or simply forgetting it altogether! The system can now be programmed the way you approach your installations, by zones!

This User Friendly Menu Mode can also be used for programming remote console characteristics, and for entering alpha descriptors.

COMMUNICATION DEFAULT PROGRAMMING

There are five sets of pre-programmed defaults available (one standard, plus four different communication defaults). Any one of these can be loaded into the system's memory. Refer to the COMMUNICATION PROGRAMMING section for instructions.

PROGRAMMING STEPS

1. Enter Programming mode (5137AD only)

Programming mode can be entered in one of two ways.

- 1) By depressing the [*] and [#] keys at the same time within 30 seconds after power is applied to the Control.
- 2) By keying the installer code, followed by depression of CODE + 0 + 0 keys. The factory installer code can be changed once in the program mode.

Immediately following entry into the program mode, the following will be displayed on a 5137AD: Program Mode
• Fill # View - 00

Following the above display, the system is ready to be programmed for the communication format parameters, or accept data entries.

2. Set Standard and/or Communication Defaults

Refer to the PROGRAMMING COMMUNICATION DEFAULTS section for further instructions if one of the four communication default programming sets is used.

NOTE: If standard defaults are to be loaded, only consoles with an address of 00-03 will be enabled. A console with one of these addresses must be used to program the system.

3. Program data fields for system parameters

Program all global programming fields, including phone numbers and account numbers, as well as any other programming fields required to customize the system to the needs of the installation. Note that program fields 1*26 & 1*27 (RF device selection) and 2*00 (number of partitions) must be programmed.

When finished, program all partitioned programming fields by entering a partition specific field number. Repeat for each partition used in the system by pressing *91 to select the next partition. Refer to the PROGRAMMING DATA FIELDS section for specific commands and instructions.

4. Use #93 Menu Mode for zone programming

Refer to the ZONE PROGRAMMING section to program zone response types, assign right loop zones and wireless zones, and assign zones to partitions.

5. Use #93 Menu Mode for device programming

Refer to the DEVICE PROGRAMMING section to assign console ID numbers and default partitions for each console, and to selectively suppress certain console sounding.

6. Use #93 Menu Mode for programming alpha descriptors (5137AD only)

Refer to the PROGRAMMING ZONE DESCRIPTIONS section to enter zone and partition descriptors and a custom installer's message.

7. Exit Programming Mode

Exit programming mode by pressing either *98 or *99. A second entry of *99 is required if the exit is being done from fields 1*00 and above. To prevent re-access to Programming mode using the installer's code, use *98. The only way to re-access Programming mode is by depressing both the [*] and [#] keys at the same time within 30 seconds of power up. Exiting by using *99 always allows reentry into Programming mode using the installer's code. Either way of exiting will allow access via downloading.

COMMUNICATION PROGRAMMING

GENERAL INFORMATION

To help expedite the installation, Ademco has incorporated 4 different communication defaults in the VISTA XMPT Control (Low Speed, Ademco Express, Ademco High Speed & Ademco's new Contact ID). These defaults automatically program industry-standard code assignments for zones, keypad panics, non-alarm and supervisory conditions, and can be loaded at any time without affecting non-communication program fields. Using these defaults saves programming time! After loading one of the communication defaults, you only need to wire the devices to their appropriate zones, and program the following:

- Central station phone number(s), fields *33 & *34
- Subscriber's account number(s), fields *32 & *90
- Zone type responses, fields *02-*05 & *01-1*05
- Delays, timeouts, and miscellaneous control options.

The system is then operational.

LOADING COMMUNICATION DEFAULTS

NOTE: Default communication commands are in second set of programming fields (fields 1*80, 1*81, 1*82 & 1*83).

Once the Programming mode is entered, clear the system's memory by pressing *97. This ensures all program fields are set to their factory set, pre-programmed values. If desired, load one of the communication default programming sets by first changing to the 1*xx set of fields (press *94), then entering one of the following field numbers:

TABLE OF DEFAULT PROGRAMMING COMMANDS

PRESS	TO LOAD THIS DEFAULT PROGRAMMING SET
*97	Loads standard default values for the panel
*80	Low Speed communication defaults
*81	Ademco Express communication defaults
*82	Ademco High Speed communication defaults
*83	Contact ID communication defaults

The program fields that are affected by loading one of the communication defaults are fields *45 - *82. Default values for each communication default are listed on the pages following the Programming Form at the end of this manual. For detailed information about reporting formats, see the SYSTEM COMMUNICATION section. After loading one of the default sets, proceed to program the system data fields as described in the PROGRAMMING DATA FIELDS section.

EASY-TO-PROGRAM COMMUNICATION FIELDS

The VISTA XMPT programming scheme eliminates the need to program zones to channels, and then channels to codes. If programming communication fields manually, simply enter whatever code (3+1, 4+1, 4+2 or Ademco Express) is to be sent for each zone (including panics, non-alarm codes and supervisory codes). **NOTE:** Enter "10" to transmit an "A", which appears as "0" at the receiver.

All zones are separated into groups of 8, with common restore, trouble and bypass codes for every 2 groups (16 zones). There are 2 double-digit entries for each code. For 3+1, 4+1, 4+2 and Ademco Express, the first entry is the alarm code for a standard report. The second entry is the ID digit for an expanded 3+1 or 4+1 report, or for a 4+2 or Ademco Express report. If the second digit is 0, only 3+1 or 4+1 (or 4+1 express) non-expanded messages will be sent. If only three digits are entered in the account number field, the ID or second digits are ignored, if entered. For Ademco High Speed format, the first digit entry is the channel assignment for that zone, and the second digit is ignored, if entered. For Contact ID reporting, the first digit entry (any non zero entry) enables reporting for that zone, and the second digit is ignored.

NOTE: Restoral reports for an event will not be sent if the event itself is not enabled, even if a restore code is programmed for that event.

ENABLING OF DIALER REPORTING BY PARTITION

In order to enable dialer reports for a partition, an account number (fields *32 & *90) must be programmed for that partition. The Control is shipped with an account number set for partition 1 only (set to FFFF). Partitions 2-8 have no account numbers pre-programmed.

In addition, in case of phone line failure, the "COMM. FAIL" message will not be displayed in partitions which do not have a primary account number programmed.

SUMMARY OF DEFAULT CONSEQUENCES

Low Speed (*94*80)

Loading this default does the following:

- Selects low speed, standard format with no checksum, for both phone numbers.
- Assigns the following report codes:
 - 03 for zones 2-47
 - 01 for zones 1 & 48-55 (fire zones)
 - 02 for zones 62,63 (panic trans), & 95, 96, 99 (keypad panics)
 - 09 for all alarm restores
- Enables all zone type restores.

ADEMCO Express (*94*81)

Loading this default does the following:

- Selects Ademco express reporting format, with checksum, for both phone numbers.
- Report codes for zones 1-64, 4280s and keypad panics are sent as their respective zone ID numbers (01-64, 88-91, 95-99), Duress is sent as "DD". Alarm restore is "E" + 2nd digit.
- Enables all zone type restores.

ADEMCO High Speed (*94*82)

Loading this default does the following:

- Selects Ademco High Speed format, with no checksum, for both phone numbers.
- Reporting is assigned to the following channels:
 - Channel 1 for zones 1 & 48-55 (Fire zones)
 - Channel 2 for zones 2-8
 - Channel 3 for zones 9-16
 - Channel 4 for zones 17-34
 - Channel 5 for zones 32-47 (RF interior zones)
 - Channel 6 for zones 56-61 & 64
 - Channel 9 for zones 62 & 63 (panic transmitter)
 - Channel 7 for 2nd 4280 (88 & 89) & polling loop short (97)
 - Channel 8 for first 4280 (90 & 91)
 - Channels 10, 11 & 12 for keypad panics 95, 96 & 99 respectively
- Enables all zone type restores.
- Enables Duress to be sent.

ADEMCO's Contact ID (*94*83)

Loading this default does the following:

- Selects Contact ID format for both phone numbers.
- Reporting is enabled for all zones.
- Enables all zone type restores.
- Refer to the SYSTEM COMMUNICATION section for event code definitions.

4140XMPT PROGRAMMING FORM

Refer to the installation instruction's INDEX OF PROGRAMMING FIELDS for numerical list of program fields.

Standard default values are shown in brackets [], otherwise default = 0.

Fields shown in *italics* can be programmed using the #93 Menu mode.

Parentheses () around a field number indicate differences from 4140xmp programming fields.

SECURITY ACCESS OPTIONS

*00 INSTALLER CODE

Enter 4 digits, 0-9 [4140]

(*15) KEYSWITCH ASSIGNMENT

Enter partition in which keyswitch used, 1-8; [0=disable]

ASSIGN RESPONSE TYPE FOR ZONES (Enter 00-10; see Response Types box below)

*02	*03	*04	*05	1*01	1*02	1*03	1*04	1*05	1*09	
1	9	17	25	28	33	41	49	57	88	2nd RCVR
2	10	18	26	29	34	42	50	58	89	2nd RCVR
3	11	19	27	30	35	43	51	59	90	1st RCVR
4	12	20	010	31	36	44	52	60	91	1st RCVR
5	13	21	97	32	37	45	53	61		Use of 1 or 2 RF RCVRs requires enabling their respective faults (88-91) as troubles (type 5). Enter 00 if no announcement is desired.
6	14	22	95	(1+8)	38	46	54	62		
7	15	23	96	(3+8)	39	47	55	63		
8	16	24	99	(8+8)	40	48	56	64		

NOTES: 97 = Poll Loop Short; 88 & 90 = RCVR not receiving transmitter signals. 89 & 91 = RCVR not responding, bad conn. to panel.

RESPONSE TYPES: 00 = Disabled zone; 01 = Entry/Exit #1; 02 = Entry/Exit #2; 03 = Perimeter; 04 = Interior Follower; 05 = Day/Night; 06 = 24 hour Silent Alarm; 07 = 24 hour Audible Alarm; 08 = 24 hour Auxiliary; 09 = Fire; 10 = Interior, Delay;

DESIGNATE RIGHT LOOP FOR MULTIPLEX EXPANSION 1=yes; [0=no]

*06	<input type="checkbox"/>	<input type="checkbox"/>	<input type="checkbox"/>	<input type="checkbox"/>	<input type="checkbox"/>	<input type="checkbox"/>	<input type="checkbox"/>	1*10	<input type="checkbox"/>	<input type="checkbox"/>	<input type="checkbox"/>	<input type="checkbox"/>	<input type="checkbox"/>	<input type="checkbox"/>	<input type="checkbox"/>	<input type="checkbox"/>	<input type="checkbox"/>
ZONES:	10	11	12	13	14	15	16	ZONES:	33	34	35	36	37	38	39	40	
*07	<input type="checkbox"/>	<input type="checkbox"/>	<input type="checkbox"/>	<input type="checkbox"/>	<input type="checkbox"/>	<input type="checkbox"/>	<input type="checkbox"/>	1*11	<input type="checkbox"/>	<input type="checkbox"/>	<input type="checkbox"/>	<input type="checkbox"/>	<input type="checkbox"/>	<input type="checkbox"/>	<input type="checkbox"/>	<input type="checkbox"/>	<input type="checkbox"/>
ZONES:	17	18	19	20	21	22	23	ZONES:	41	42	43	44	45	46	47	48	
*08	<input type="checkbox"/>	<input type="checkbox"/>	<input type="checkbox"/>	<input type="checkbox"/>	<input type="checkbox"/>	<input type="checkbox"/>	<input type="checkbox"/>	1*12	<input type="checkbox"/>	<input type="checkbox"/>	<input type="checkbox"/>	<input type="checkbox"/>	<input type="checkbox"/>	<input type="checkbox"/>	<input type="checkbox"/>	<input type="checkbox"/>	<input type="checkbox"/>
ZONES:	25	26	27	28	29	30	31	ZONES:	49	50	51	52	53	54	55	56	
*24	4190WH TAMPER DISABLE	<input type="checkbox"/>	1=disable; [0=enable]		1*13	<input type="checkbox"/>	<input type="checkbox"/>	<input type="checkbox"/>	<input type="checkbox"/>	<input type="checkbox"/>	<input type="checkbox"/>	<input type="checkbox"/>	<input type="checkbox"/>	<input type="checkbox"/>	<input type="checkbox"/>	<input type="checkbox"/>	<input type="checkbox"/>
*86	ZONE EXPANDER DEVICE	<input type="checkbox"/>	1=only one 4208 installed for zones 10-17; [0=more than one 4208 or other device]		ZONES:	57	58	59	60	61	62	63	64				

SELECTION OF WIRELESS FOR ZONES 1-63

Enter "1" to enable a zone as wireless; 0=non-wireless

1*18	<input type="checkbox"/>	<input type="checkbox"/>	<input type="checkbox"/>	<input type="checkbox"/>	<input type="checkbox"/>	<input type="checkbox"/>	<input type="checkbox"/>										
ZONES:	1	2	3	4	5	6	7	8									
1*19	<input type="checkbox"/>	<input type="checkbox"/>	<input type="checkbox"/>	<input type="checkbox"/>	<input type="checkbox"/>	<input type="checkbox"/>	<input type="checkbox"/>										
ZONES:	9	10	11	12	13	14	15	16									
1*20	<input type="checkbox"/>	<input type="checkbox"/>	<input type="checkbox"/>	<input type="checkbox"/>	<input type="checkbox"/>	<input type="checkbox"/>	<input type="checkbox"/>										
ZONES:	17	18	19	20	21	22	23	24									
1*21	<input type="checkbox"/>	<input type="checkbox"/>	<input type="checkbox"/>	<input type="checkbox"/>	<input type="checkbox"/>	<input type="checkbox"/>	<input type="checkbox"/>										
ZONES:	25	26	27	28	29	30	31	32									
1*22	<input type="checkbox"/>	<input type="checkbox"/>	<input type="checkbox"/>	<input type="checkbox"/>	<input type="checkbox"/>	<input type="checkbox"/>	<input type="checkbox"/>										
ZONES:	33	34	35	36	37	38	39	40									
1*23	<input type="checkbox"/>	<input type="checkbox"/>	<input type="checkbox"/>	<input type="checkbox"/>	<input type="checkbox"/>	<input type="checkbox"/>	<input type="checkbox"/>										
ZONES:	41	42	43	44	45	46	47	48									
1*24	<input type="checkbox"/>	<input type="checkbox"/>	<input type="checkbox"/>	<input type="checkbox"/>	<input type="checkbox"/>	<input type="checkbox"/>	<input type="checkbox"/>										
ZONES:	49	50	51	52	53	54	55	56									
1*25	<input type="checkbox"/>	<input type="checkbox"/>	<input type="checkbox"/>	<input type="checkbox"/>	<input type="checkbox"/>	<input type="checkbox"/>	<input type="checkbox"/>										
ZONES:	57	58	59	60	61	62	63										

MISCELLANEOUS WIRELESS OPTIONS

1*26	FIRST RF RECEIVER SELECT	<input type="checkbox"/>	1=yes; [0=no]
1*27	SECOND RF RECEIVER SELECT	<input type="checkbox"/>	1=yes; [0=no]
1*28	RF TRANSMITTER LOW BATTERY ANNUN.	<input type="checkbox"/>	1=immediate; [0=when disarmed]
1*29	RF TRANSMITTER LOW BATTERY REPORT ENABLE	<input type="checkbox"/>	1=enable; [0=disable] Must be "1" for UL
1*30	RF RECEIVER SUPERVISION CHECK-IN INTERVAL	<input type="checkbox"/>	02-15 times 2 hours; 00 disables supervision [6] Max. "8" (12 hr) for UL
1*31	RF TRANSMITTER CHECK-IN INTERVAL	<input type="checkbox"/>	02-15 times 2 hours; 00 disables transmitter supervision [12] Max. "8" (12 hr) for UL
1*44	WIRELESS KEYPAD TAMPER DETECT ENABLE	<input type="checkbox"/>	1=enable; [0=disable]
(1*48)	WIRELESS KEYPAD ASSIGNMENT	<input type="checkbox"/>	0=disable; enter partition in which RF keypad used, 1-8.
1*49	DISABLE TROUBLE FOR RF SUPERVISION	<input type="checkbox"/>	[1=disable]; 0=enable. Must be "0" for UL.

AC LOSS OPTIONS

*17	AC POWER LOSS SOUNDING	<input type="checkbox"/>	1=yes; [0=no]
*18	AC POWER LOSS ALARM	<input type="checkbox"/>	1=yes; [0=no]
*19	AC RANDOMIZE	<input type="checkbox"/>	1=randomize 10-40 min.; [0=no]
*28	POWER UP IN PREVIOUS STATE	<input type="checkbox"/>	[1=yes]; 0=no; "1" for UL.

265

MISCELLANEOUS SYSTEM OPTIONS

- *14 ZONE 9 FAST/SLOW RESP 1=fast; [0=slow]; '0' for UL
- *21 DISABLE FIRE TIME-OUT 1=no timeout; [0=fire timeout]
- (*25) BURGLARY TRIGGER FOR ZONE RESPONSE TYPE 8 [1=enable]; [0=disable]
- *41 EOLR DISABLE (Zones 2-8)
[1=N.C. loops]; [0=EOLR supervision]; Must be '0' for UL.
- 1*46 AUXILIARY OUTPUT ENABLE
[0=ground start]; 1=open/close trigger; 2=console sounding

TEST TIMER OPTIONS

- *26 INTELLIGENT TEST REPORTING Set '0' for UL
1=yes, (no report sent if any other report was recently sent); [0=no]
- *27 TEST REPORT INTERVAL
Enter interval in hours, 001-199; 000=no report; [024]; Max. 024 for UL.
- *83 FIRST TEST REPORT TIME
[Day 00-01; 2: min 00] Days 01-07 Hours 00-23 Min 00-59;
00 in all boxes=instant (Day 01=Monday)
- (*89) RESTORE REPORT TIMING
[0=instant]; 1=at bell timeout; 2=at disarm

PHONE LINE & COMMUNICATOR OPTIONS

- *30 TOUCH-TONE OR ROTARY DIAL 1=TouchTone; [0=rotary]
- 1*33 TOUCH-TONE W/ROTARY BACKUP ENABLE 1=enable; [0=disable]
- *33 PRIMARY PHONE NUMBER
Enter 0-9 for each digit
- *34 SECONDARY PHONE NUMBER
Enter 0-9 for each digit
- *42 DIAL TONE PAUSE
[0=5 seconds]; 1=11 seconds; 2=30 seconds; Must be '0' for UL.
- *43 DIAL TONE DETECTION
[1=wait for true dial tone]; [0=pause, then dial]
- *45 PRIMARY FORMAT
[0=Low Speed]; 1=Contact ID; 2=Ademco High Speed; 3=Ademco Express
- *46 LOW SPEED FORMAT (Primary)
[0=Ademco Low Speed]; 1=Seccoa/Radionics
- *47 SECONDARY FORMAT
[0=Low Speed]; 1=Contact ID; 2=Ademco High Speed; 3=Ademco Express
- *48 LOW SPEED FORMAT (Sec.)
[0=Ademco Low Speed]; 1=Seccoa/Radionics
- *49 CHECKSUM VERIFICATION
1=yes; [0=no] Primary Secondary
- *50 SESCOA/RADIONICS SELECT 1=Seccoa; [0=Radionics]
- *31 PABX ACCESS CODE
00-09; B-F (11-15)
- *51 DUAL REPORTING
1=yes; [0=no] If used with Split Reporting "1" option (1*34), alarms go to both primary & secondary numbers, while all other reports go to secondary only. If used with Split Reporting "2" option, open/close and test messages go to both lines, while all other reports go to primary.
- 1*34 COMM. SPLIT REPORT SELECTION
[0=no]; 1=alarms primary, others secondary;
2=open/close, test secondary, others primary; See *51 for comments.
- *52 STANDARD/EXPANDED REPORT FOR PRIMARY
Alarm Rstr Bypass Trbl OpnCls Low Bat
[0=standard]; 1=expanded; Note: Expanded overrides 4+2 format.
- *53 STANDARD/EXPANDED REPORT FOR SECONDARY
Alarm Rstr Bypass Trbl OpnCls Low Bat
[0=standard]; 1=expanded; Note: Expanded overrides 4+2 format.

DOWNLOADING OPTIONS

- *35 DOWNLOAD PHONE No.
Enter 0-9 for each digit
- *36 DOWNLOAD ID No.
Enter 00-09; A-F (10-15) [15 15 15 15 15 15 15]
- *37 DOWNLOAD COMMAND ENABLES 0
[1=enable]; [0=disable] Dialer System Not Remote Remote Remote Upload Download
See field 1*53 for Callback disable option Shutdown Shutdown Used Bypass Disarm Arm Program Program
For UL installations, Upload & Download must be enabled. All others must be disabled.
- *44 RING DETECTION COUNT
01-14; 15=answering machine; [00=no detection]
- 1*53 DOWNLOAD CALLBACK
1=callback not required; [0=callback required]; Must be '0' for UL.

PARTITIONED SYSTEM PROGRAMMING FIELDS

- (2*00) NUMBER OF PARTITIONS Enter 1-8 [1] (2*19) USE PARTITION DESCRIPTORS [0=disable]; 1=enable
 - NUMBER OF CODES PER PARTITION (2*17) Enter 01-99. Total must be less than or equal to 128. [Default=99 in part. 1; 01 in all other partitions]
 - ASSIGN ZONES TO A PARTITION Enter 1-8
- | (2*01) | (2*02) | (2*03) | (2*04) | (2*05) | (2*06) | (2*07) | (2*08) |
|---------------------------------|----------------------------------|----------------------------------|----------------------------------|----------------------------------|----------------------------------|----------------------------------|----------------------------------|
| 1 <input type="text" value=""/> | 9 <input type="text" value=""/> | 17 <input type="text" value=""/> | 25 <input type="text" value=""/> | 33 <input type="text" value=""/> | 41 <input type="text" value=""/> | 49 <input type="text" value=""/> | 57 <input type="text" value=""/> |
| 2 <input type="text" value=""/> | 10 <input type="text" value=""/> | 18 <input type="text" value=""/> | 26 <input type="text" value=""/> | 34 <input type="text" value=""/> | 42 <input type="text" value=""/> | 50 <input type="text" value=""/> | 58 <input type="text" value=""/> |
| 3 <input type="text" value=""/> | 11 <input type="text" value=""/> | 19 <input type="text" value=""/> | 27 <input type="text" value=""/> | 35 <input type="text" value=""/> | 43 <input type="text" value=""/> | 51 <input type="text" value=""/> | 59 <input type="text" value=""/> |
| 4 <input type="text" value=""/> | 12 <input type="text" value=""/> | 20 <input type="text" value=""/> | 28 <input type="text" value=""/> | 36 <input type="text" value=""/> | 44 <input type="text" value=""/> | 52 <input type="text" value=""/> | 60 <input type="text" value=""/> |
| 5 <input type="text" value=""/> | 13 <input type="text" value=""/> | 21 <input type="text" value=""/> | 29 <input type="text" value=""/> | 37 <input type="text" value=""/> | 45 <input type="text" value=""/> | 53 <input type="text" value=""/> | 61 <input type="text" value=""/> |
| 6 <input type="text" value=""/> | 14 <input type="text" value=""/> | 22 <input type="text" value=""/> | 30 <input type="text" value=""/> | 38 <input type="text" value=""/> | 46 <input type="text" value=""/> | 54 <input type="text" value=""/> | 62 <input type="text" value=""/> |
| 7 <input type="text" value=""/> | 15 <input type="text" value=""/> | 23 <input type="text" value=""/> | 31 <input type="text" value=""/> | 39 <input type="text" value=""/> | 47 <input type="text" value=""/> | 55 <input type="text" value=""/> | 63 <input type="text" value=""/> |
| 8 <input type="text" value=""/> | 16 <input type="text" value=""/> | 24 <input type="text" value=""/> | 32 <input type="text" value=""/> | 40 <input type="text" value=""/> | 48 <input type="text" value=""/> | 56 <input type="text" value=""/> | 64 <input type="text" value=""/> |

ALARM REPORT CODE & ID DIGITS FOR ZONES 1-32 & SUPV. & RESTORE CODES [All codes default to 00]

*54 CODE	*55 ID	*56 CODE	*57 ID	*58	*59 CODE	*60 ID	*61 CODE	*62 ID	*63
1		9		Alarm Rst.	17		25		Alarm Rst.
2		10		Trouble	18		26		Trouble
3		11		Trble Rst.	19		27		Trble Rst.
4		12		Bypass	20		28		Bypass
5		13		Bypass Rst.	21		29		Bypass Rst.
6		14			22		30		
7		15			23		31		
8		16			24		32		

ALARM REPORT CODE & ID DIGITS FOR ZONES 33-64 & SUPERV. & RESTORE CODES [All codes default to 00]

*64 CODE	*65 ID	*66 CODE	*67 ID	*68	*69 CODE	*70 ID	*71 CODE	*72 ID	*73
33		41		Alarm Rst.	49		57		Alarm Rst.
34		42		Trouble	50		58		Trouble
35		43		Trble Rst.	51		59		Trble Rst.
36		44		Bypass	52		60		Bypass
37		45		Bypass Rst.	53		61		Bypass Rst.
38		46			54		62		
39		47			55		63		
40		48			56		64		

ALARM REPORT CODE & ID DIGITS FOR RF RCVRs & PANICS, & THEIR SUPV. & RESTORE CODES

[All codes default to 00]

*74 CODE	*75 ID	*78
88		Alarm Rst.
*76 CODE	*77 ID	Trouble
89		Trble Rst.
90		Bypass
91		Bypass Rst.
		Duress
97		Poll loop short
95		(1 + #)
96		(3 + #)
99		(# + #)

NOTES: 97 = Poll Loop Short; 88 & 90 = RCVR not receiving transmitter signals. 89 & 91 = RCVR not responding, bad conn. to panel.

SYSTEM NON ALARM CODES

	*81	*82
	First Digit	Second Digit
Close		
Open		
Low Battery		
Low Bat Res		
AC Loss		
AC Restore		
Test		
Power		
Cancel		
Prog. Tamp.		

Second digit of each code applies only to 4+2 or expanded (fields *52 & *53) formats.

ZONE TYPE RESTORE ENABLES 1=enable; [0=disable]

*79	ZONE TYPES 1-8	*80	TYPES 9&10
	1 2 3 4 5 6 7 8		9 10

OPEN/CLOSE REPORTING FOR KEYSWITCH

(*40) 1=enable; [0=disable]

EVENT LOGGING FIELDS

(Real time clock must be set-code + [#] + 63)

(1*70) EVENT LOG TYPES
 1=enable logging; 0=disable Alarm Chk Byp OC System

(1*71) 12/24 HOUR TIME STAMP FORMAT
 [0=12 hour]; 1=24 hour

(1*72) EVENT LOG PRINTER ON-LINE
 [0=disable]; 1=enable

(1*73) PRINTER BAUD RATE 1=300; [0=1200]

EVENT LOGGING DIALER CODES

	1*40	1*41
	First Digit	Second Digit
Armed STAY		
Time/Date set or event log reset		
Event log 50% & 90% full		
Event log overflow		

PARTITION-SPECIFIC PROGRAM FIELDS

(Duplicate this page for the partitions used in the installation.)

To program these fields, enter a partition-specific field number.

To select the next partition, press *91.

To return to the global program fields, press *99.

PARTITION #	PROGRAM FIELDS
*09	ENTRY DELAY #1 <input type="text"/> <input type="text"/> [02] (00-15 times 15 seconds)
*10	EXIT DELAY #1 <input type="text"/> <input type="text"/> [03] (00-15 times 15 seconds)
*11	ENTRY DELAY #2 <input type="text"/> <input type="text"/> [06] (00-15 times 15 seconds)
*12	EXIT DELAY #2 <input type="text"/> <input type="text"/> [06] (00-15 times 15 seconds)
*13	ALARM SOUNDER DURATION <input type="text"/> <input type="text"/> 01-15 times 2 minutes [04]. Minimum 4 minutes for UL.
*16	CONFIRMATION OF ARMING DING <input type="checkbox"/> 1=enable; [0=disable]
*22	CONSOLE PANIC ENABLES <input type="checkbox"/> <input type="checkbox"/> <input type="checkbox"/> 1=enable; 0=disable [0-0-1] 95 96 99
*23	MULTIPLE ALARMS <input type="checkbox"/> [1=yes]; 0=no
*29	QUICK ARM <input type="checkbox"/> [1=yes]; 0=no
*32	PRIMARY SUBSCRIBER ACCT # <input type="text"/> <input type="text"/> <input type="text"/> <input type="text"/> <input type="text"/> <input type="text"/> Enter 00-09; B-F (11-15) [15 15 15 15]
*38	INHIBIT BYPASS OF A ZONE <input type="text"/> <input type="text"/> 01-31; [00 if all zones (except Fire zones) can be bypassed]
*39	ENABLE OPEN/CLOSE REPORT <input type="checkbox"/> FOR INSTALLER CODE 1=enable; [0=disable]
*84	SWINGER SUPPRESSION <input type="text"/> <input type="text"/> 01-15 alarms [15]; Must be "00" (disabled) for UL.
*85	ENABLE DIALER REPORTS <input type="checkbox"/> <input type="checkbox"/> <input type="checkbox"/> <input type="checkbox"/> FOR PANICS & DURESS 95 96 99 Duress 1=enable; [0=disable]
*87	ENTRY WARNING <input type="checkbox"/> [1=continuous]; 0=3 beeps
*88	BURG. ALARM COMM. DELAY <input type="text"/> <input type="text"/> 1=16 seconds; [0=no delay]
*90	SECONDARY SUBSCRIBER ACCT # <input type="text"/> <input type="text"/> <input type="text"/> <input type="text"/> <input type="text"/> <input type="text"/> Enter 00-09; B-F (11-15) [15 15 15 15]
1*43	ENABLE PERM. BACKLIGHT <input type="checkbox"/> 1=enable; [0=disable]
1*45	ENABLE CONSOLE <input type="checkbox"/> 1=enable; [0=disable] ANNUN. DURING EXIT DELAY
1*47	ENABLE CHIME ANNUN. <input type="checkbox"/> 1=enable; [0=disable] ON EXTERNAL ALARM SOUNDER
1*52	CANCEL REPORT RESTRICTION <input type="checkbox"/> 1=no restriction; [0=within Bell Timeout period only]
2*18	ENABLE GOTO FOR THIS PARTITION <input type="checkbox"/> 1=enable; [0=disable]

PARTITION #	PROGRAM FIELDS
*09	ENTRY DELAY #1 <input type="text"/> <input type="text"/> [02] (00-15 times 15 seconds)
*10	EXIT DELAY #1 <input type="text"/> <input type="text"/> [03] (00-15 times 15 seconds)
*11	ENTRY DELAY #2 <input type="text"/> <input type="text"/> [06] (00-15 times 15 seconds)
*12	EXIT DELAY #2 <input type="text"/> <input type="text"/> [06] (00-15 times 15 seconds)
*13	ALARM SOUNDER DURATION <input type="text"/> <input type="text"/> 01-15 times 2 minutes [04]. Minimum 4 minutes for UL.
*16	CONFIRMATION OF ARMING DING <input type="checkbox"/> 1=enable; [0=disable]
*22	CONSOLE PANIC ENABLES <input type="checkbox"/> <input type="checkbox"/> <input type="checkbox"/> 1=enable; 0=disable [0-0-1] 95 96 99
*23	MULTIPLE ALARMS <input type="checkbox"/> [1=yes]; 0=no
*29	QUICK ARM <input type="checkbox"/> [1=yes]; 0=no
*32	PRIMARY SUBSCRIBER ACCT # <input type="text"/> <input type="text"/> <input type="text"/> <input type="text"/> <input type="text"/> <input type="text"/> Enter 00-09; B-F (11-15) [15 15 15 15]
*38	INHIBIT BYPASS OF A ZONE <input type="text"/> <input type="text"/> 01-31; [00 if all zones (except Fire zones) can be bypassed]
*39	ENABLE OPEN/CLOSE REPORT <input type="checkbox"/> FOR INSTALLER CODE 1=enable; [0=disable]
*84	SWINGER SUPPRESSION <input type="text"/> <input type="text"/> 01-15 alarms [15]; Must be "00" (disabled) for UL.
*85	ENABLE DIALER REPORTS <input type="checkbox"/> <input type="checkbox"/> <input type="checkbox"/> <input type="checkbox"/> FOR PANICS & DURESS 95 96 99 Duress 1=enable; [0=disable]
*87	ENTRY WARNING <input type="checkbox"/> [1=continuous]; 0=3 beeps
*88	BURG. ALARM COMM. DELAY <input type="text"/> <input type="text"/> 1=16 seconds; [0=no delay]
*90	SECONDARY SUBSCRIBER ACCT # <input type="text"/> <input type="text"/> <input type="text"/> <input type="text"/> <input type="text"/> <input type="text"/> Enter 00-09; B-F (11-15) [15 15 15 15]
1*43	ENABLE PERM. BACKLIGHT <input type="checkbox"/> 1=enable; [0=disable]
1*45	ENABLE CONSOLE <input type="checkbox"/> 1=enable; [0=disable] ANNUN. DURING EXIT DELAY
1*47	ENABLE CHIME ANNUN. <input type="checkbox"/> 1=enable; [0=disable] ON EXTERNAL ALARM SOUNDER
1*52	CANCEL REPORT RESTRICTION <input type="checkbox"/> 1=no restriction; [0=within Bell Timeout period only]
2*18	ENABLE GOTO FOR THIS PARTITION <input type="checkbox"/> 1=enable; [0=disable]

PROGRAMMING DATA FIELDS

KEY COMMANDS	
*94	Next set of fields
*99	Previous set of fields or exit programming mode
*91	Select new partition
*93	Enter Zone/Alpha/Device Programming mode
*98	Exit programming mode with installer lock-out

GLOBAL PROGRAMMING FIELDS

The global (i.e. non-partition specific) programming fields are grouped into three sets (or "pages"), as represented in the diagram below. The first set is accessed as soon as programming mode is entered. To access the other sets of fields (indicated on the programming form by a "1" or "2" in front of the 2-digit field address), press *94. Note that the alpha consoles display the words ALT PROGRAM MODE to indicate the higher set of fields. To return to the previous set of fields, press *99. When programming data fields, the fields listed in the table in the ZONE PROGRAMMING section can be skipped, since they can be programmed using the user-friendly ZONE PROGRAMMING Menu Mode.

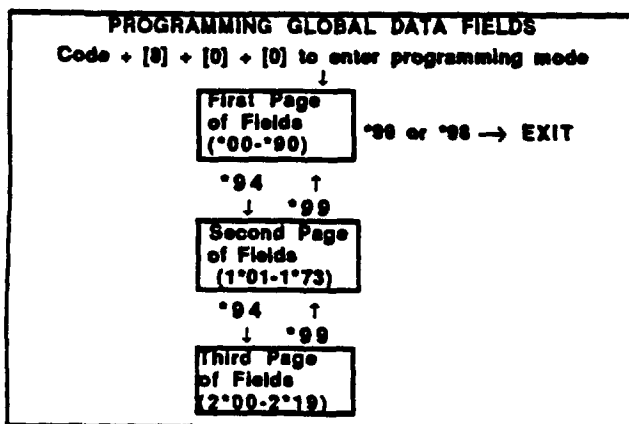

To program specific data fields, press [#] plus the 2-digit field address, then make the required entry. The console will beep when a field has been completely programmed and will automatically display the next field in sequence. Partitioned programming fields are skipped (refer to PARTITIONING PROGRAMMING paragraph). If the number of digits that you enter in the data field is less than the maximum permitted (ex. phone number), the console displays the last entry and waits. To proceed, the next data field to be programmed must be entered manually (ex. press *05).

To view the contents of a data field, press [#] plus the 2-digit field address. The field's entries will be displayed, but no changes can be made.

In case of errors: If an address is improperly entered, the console will display FC. If a program entry is improperly entered (for example, a larger number than that which is permitted), the console display will go blank. In either case, simply re-enter the correct number.

PARTITION PROGRAMMING

Values for some programming fields are system wide (global), and some can be different for each partition. Listed in the table below are the specific fields that can be defined for each partition.

To access partition specific fields, enter a partition specific field number (ex. *09). The display will prompt for the desired partition number. Once the partition number is entered, the partition specific fields for that partition can be programmed. When completed, press *91 to select the next partition's programming fields.

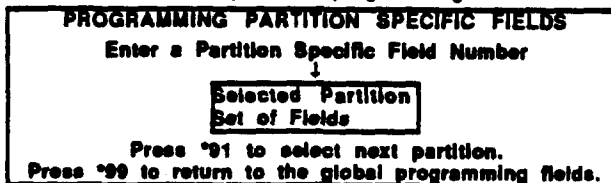

In addition, zones and consoles must be assigned a default partition by using the #93 Menu mode. Note that each console can also be individually programmed to suppress arm/disarm beeps, entry/exit beeps and chime mode beeps by using the #93 Menu Mode. This helps prevent unwanted sounds from disturbing users in other areas of the premises.

The partitioned programming fields are automatically skipped when programming the global fields. To access these programming fields, press *91, which will prompt you for the partition number desired. After all fields in that partition are programmed, press *91 to program the next partition's parameters. Repeat for all partitions used in the system.

PARTITIONED PROGRAMMING FIELDS

*09-12	ENTRY/EXIT DELAYS
*13	ALARM SOUNDER DURATION
*16	CONFIRMATION OF ARMING DING
*22	ENABLE CONSOLE PANIC KEYS
*23	MULTIPLE ALARMS
*29	QUICK ARM
*32	PRIMARY SUBSCRIBER ACCT #
*38	INHIBIT BYPASS OF ONE ZONE
*39	ENABLE OPEN/CLOSE REPORTS FOR INSTALLER CODE
*84	SWINGER SUPPRESSION
*85	ENABLE DIALER REPORTS FOR PANICS & DURESS
*87	ENTRY WARNING
*88	BURG. ALARM COMM. DELAY
*90	SEC. SUBSCRIBER ACCT. No.
1*43	ENABLE PERMANENT KEYPAD BACKLIGHTING
1*45	ENABLE CONSOLE ANNUN. DURING EXIT DELAY
1*47	ENABLE CHIME ANNUN. ON EXT. ALARM SOUNDER
1*52	CANCEL REPORT RESTRICTION
2*18	ENABLE GOTO FOR PARTITION

#93 USER FRIENDLY MENU MODE

GENERAL INFORMATION

After programming all system related programming fields in the usual way, press #93 to display the first choice of the three menu driven programming functions, which are: Zone Programming (for programming zone types and assigning to partitions), Alpha Programming (for programming alpha descriptors) & Device Programming (for programming console characteristics). Press 0 (NO) or 1 (YES) in response to the selection. Pressing 0 will display the next choice in sequence. Refer to the ZONE PROGRAMMING section for instructions for programming zone characteristics, the DEVICE PROGRAMMING section for instructions for programming remote consoles, and the ALPHA PROGRAMMING section for programming alpha descriptors. The list of commands used while in the menu mode is shown at the right.

#93 MENU MODE KEY COMMANDS

#93	Enters Menu mode
[#]	Serves as ENTER key. Press to have console accept entry.
[#]	Skips to next screen display without changing existing entries.
0	Press to answer NO
1	Press to answer YES
01-09	All entries are 2-digit entries
00	Escapes from menu mode, back into field programming mode.

NOTE: The following fields should be preset before beginning: 1*26 First RF Expander; 1*27 Second RF Expander; 2*00 Number of Partitions.

ZONE PROGRAMMING

The following fields can be programmed by using the ZONE PROGRAMMING Menu Mode:

ZONE PROGRAMMING FIELDS

02-05	Zone response types for zones 1-27
06-08	Right loop assignment for zones 10-32
01-05	Zone response types for zones 28-64
09	Zone response types for RF receivers
10-13	Right loop assignment for zones 33-64
18-25	Wireless zone assignments for zones 1-63
01-08	Zone partition assignments for zones 1-64

IMPORTANT!: Note that before programming zone characteristics, fields 1*26 & 1*27 (RF Expander Selects) and field 2*00 (number of partitions) must be programmed. This identifies the use of RF Receivers and the number of partitions being used in the system.

1. Enter Programming mode, then press #93 to display "ZONE PROG?". Press 1 to enter ZONE PROGRAMMING mode.
2. Enter the zone number to be programmed (01-64, 88-91, 95, 96, 97 or 99). Press [#] to accept entry.
3. Enter the zone response type for that zone (01-10). The screen will automatically display the zone type for the number entered. Press [#] to accept entry. If a different zone response type is desired, enter a different number and press [#].
4. Depending on whether or not RF Expansion has been programmed, and if this zone is between 1-63, the system will ask if this is an RF (wireless) zone. Enter 1 for yes, 0 for no. Press [#] to accept entry.
5. If the zone number is between 10-64 and the zone has not been selected as a wireless zone, the system will ask if this is a right loop zone. Enter 1 for yes, 0 for no. Press [#] to accept entry.
6. Enter the partition number for this zone. Press [#] to accept entry.

The display will repeat with the zone number question for programming the other zones in the system. Enter 00 to exit back to normal programming mode.

DEVICE PROGRAMMING

1. Enter Programming mode, then press #93 to display "ZONE PROG?". Press 0 (NO) to display "ALPHA PROG?". Press 0 again to display "DEVICE PROG?". Press 1 to enter DEVICE PROGRAMMING mode.
2. Enter the 2-digit console ID number as set by its DIP switches (01-31). Press [#] to accept entry.
3. Select the type of console, alpha or fixed-word, as prompted (01=alpha; 02=fixed-word). Press [#] to accept entry. Entering 00 = console not used.
4. Enter the console's default partition number (01 to maximum number of partitions programmed for system in field 2*00). This is the primary partition for which the console is intended to be used. Press [#] to accept entry.
5. Enter a number 00-03 for the console sounding suppression options desired for this console as follows:
Enter 00 for no suppression.
Enter 01 to suppress arm/disarm & entry/exit beeps.
Enter 02 to suppress chime mode beeps only.
Enter 03 to suppress arm/disarm, entry/exit and chime mode beeps.
The screen will display the next console number to be programmed.
6. Press 00 to exit Menu Mode.

NOTE: Console address 00 is always be set to an alpha console with no sounder suppression options.

ALPHA PROGRAMMING

Assigning Zone & Partition Descriptors

If using a 5137AD console, a user friendly English language description/location of all protection zones, partitions keypad panics, polling loop short and 4280 supervision faults can be programmed into the system. Each description can be composed of a combination of words (up to a maximum of 3) that are selected from a vocabulary of approximately 220 words stored in memory, and any word can have an "s" or " 's " added to it. In addition, up to 20 installer-defined words can be added to those already in memory. Thus, when an alarm or trouble occurs in a zone, an appropriate description for the location of that zone will be displayed at the console. An installer's message can also be programmed for each partition which will be displayed when the system is "Ready" (ex. THE PETERSON'S).

Entering Zone Descriptors

1. Select ZONE DESCRIP mode.
The console keys perform the following functions:
 - [3] Scrolls both alphabet and actual words in ascending alphabetical order.
 - [1] Scrolls both alphabet and actual words in descending alphabetical order.
 - [2] Adds or removes an "s" or " 's " to a vocabulary word.
 - [6] Toggles between alphabet and actual word list; used to accept entries.
 - [8] Saves the zone description in the system's memory.
 - [#] # plus zone number will display the description for that zone.
2. Key *01 to begin entering the description for zone 1, (key *02 for zone 2, *03 for zone 3 etc.). The following will be displayed: * ZN 01 A
Note that the first letter of the alphabet appears after the zone number, and that the zone number is automatically included with the description.
3. Select the first letter of the desired description (note that "A" is already displayed). Use key [3] to advance through the alphabet and key [1] to go backward. For example, assume the desired description for zone 1 is BACK DOOR. Press key [3] repeatedly (or hold down the key) until "B" appears, then press key [6]. to display the first available word beginning with B. Repeatedly press key [3] to advance through the available words until the word BACK is displayed. Press key [1] to move backward through the word list.
To add an "s" or " 's ", press the [2] key. The first depression adds an "s", the second depression adds an " 's ", the third depression displays no character (to erase the character), the fourth depression adds an "s", etc.
To accept the word, press the [6] key, which toggles back to alphabet list.
4. For selection of the next word (DOOR), repeat step 3, but press key [3] until the desired first letter of the next word appears (in this example, "D"). Then press key [6] to display the first available word beginning with "D". Press key [3] repeatedly until the desired word (DOOR) appears. To accept the word, press the [6] key, which again toggles back to alphabet list.
5. When all desired words have been entered, press key [8] to store the description in memory.
6. To review the zone descriptions, key [#] plus zone number (e.g., #01). To edit zone descriptions, key [*] plus zone number (e.g., *01)
7. To exit the zone description mode, key 00.

NOTE: Alpha descriptor entry can be entered locally at the 5137AD console or remotely using a 4130PC Downloader.

To program alpha descriptors, enter Programming mode, then press #93 to display "ZONE PROG?". Press 0 (NO) to display "ALPHA PROG?". Press 1 to enter ALPHA PROGRAMMING mode. There are 5 sub-menu selections that will be displayed one at a time. Press 1 to select the mode desired. Press 0 to display the next mode available. The alpha sub menu selections are:

ZONE DESCRIP.?	for entering zone descriptors.
DEFAULT SCREEN?	for creating custom message; shows when system ready.
CUSTOM WORD?	for creating custom words for use in descriptors.
PART DESCRIP?	for creating 4-character partition names.
EXIT EDIT MODE?	Press 1 to exit back to #93 Menu Mode.

Adding Custom Words

Up to 20 installer-defined words can be added to the built-in vocabulary. Each of the 20 "words" can actually consist of several words, but bear in mind that a maximum of 10 characters can be used for each word string.

1. Select CUSTOM WORD mode. The keys perform the following functions:
 - [3] Advances through alphabet in ascending order.
 - [1] Advances through alphabet in descending order.
 - [6] Selects desired letter; moves the cursor 1 space right.
 - [4] Moves the cursor one space to the left.
 - [7] Inserts a space at the cursor location, erasing any character at that location.
 - [8] Saves the new word in the system's memory.
 - [*] Returns to description entry mode.
4. Key the number of the custom word or word string to be created (01-20). For example, if you are creating the first word (or word string), enter 01; when creating the second word, enter 02, and so on. A cursor will now appear at the beginning of the second line.
5. Use the [3] key to advance through the alphabet (numbers, symbols and special characters are included). Use the [1] key to move back through the alphabet.
IMPORTANT: Custom words must begin with an alphabetic character. If numbers or symbols are used as the first character, the word will not be saved.
6. When you have reached the desired character, press the [6] key to select it. The cursor will then move to the right, in position for the next character.
7. Repeat steps 5 and 6 to create the desired word (or words). Note that the [4] key can be used to move the cursor to the left if necessary, and that key [7] can be used to enter a blank (or to erase an existing character). Each word or word string cannot exceed 10 characters.
8. Press the [8] key to save the custom word(s) and return to the * ED ?? display. The custom word (or string of words) will be automatically added to the built-in vocabulary at the end of the group of words beginning with the same letter.
9. Repeat steps 4 through 8 to create up to 19 additional custom words (or word strings).
10. Press the [*] key to return to the *ZN ?? display, and follow the zone description entry procedure to assign the new words to a zone description.
11. Key 00 to exit the zone description programming mode.

Creating Partition Descriptors

1. Select "Part DESCRIPT." mode. The system will ask for the partition number desired. Enter the number as a single key.
2. Follow the same procedure as for CUSTOM WORDS, except that partition descriptors are limited to four (4) characters (ex. WHSE for warehouse).

Creating A Custom Message Display (Installer's Message)

Normally, when the system is in the disarmed state, the following display is present on the Console.

****DISARMED**** READY TO ARM

Part or all of the above message can be modified to create a custom installer message for each partition. For example, ****DISARMED**** on the first line or READY TO ARM on the second line could be replaced by the installation company name or phone number for service. Note that there are only 16 character spaces on each of the two lines. To create a custom display message, proceed as follows:

1. Select DEFAULT SCREEN mode. The console will ask for the partition number for this message. Enter the partition number number. Press [*] to accept entry.

The following will appear:

****DISARMED****

READY TO ARM

A cursor will be present at the extreme left of the first line (over the first "star"). The [6] key is used to move the cursor to the right and the [4] key to move the cursor to the left. Key [7] may be used to insert spaces or erase existing characters.

2. For example, to replace READY TO ARM with the message SERVICE:424-0177, proceed as follows:

Press the [6] key to move the cursor to the right, and continue until the cursor is positioned over the first location on the second line.

Press the [3] key to advance through the alphabet to the first desired character (in this case, "S"). Use the [1] key to go backward, when necessary. When the desired character is reached, press [6]. The cursor will then move to the next position, ready for entry of the next character (in this example, "E"). When the cursor reaches a position over an existing character, pressing the [3] or [1] key will advance or back up from that character in the alphabet. Proceed in this manner until all characters in the message have been entered.

3. To store this new display message in memory, press the [8] key.
4. Press the [*] key to return to the * ZN ?? display. To confirm that the new message has been stored in memory, press 00 and then press 00 again. The new message should be displayed.
5. Key 00 to exit the descriptor/programming mode.

VOCABULARY OF WORDS STORED IN MEMORY* (5137 CONSOLE ONLY)

AIR	COLD	FOIL	MAGNETIC	REFRIGERATIO	THERMOSTAT
ALARM	COATROOM	FOYER	MAIDS	N	TOOL
ALCOVE	COLLECTION	FREEZER	MAIN	FF	TRANSMITTER
ALLEY	COMBUSTION	FRONT	MASTER	RIGHT	TRAP
AMBUSH	COMPUTER	FUR	MAT	ROOM	ULTRA
AREA	CONTACT	FURNACE	MEDICAL	ROOF	UP
APARTMENT	DAUGHTERS	GALLERY	MEDICINE	SAFE	UPPER
ART	DELAYED	GARAGE	MICROWAVE	SCREEN	UPSTAIRS
ATTIC	DEN	GAS	MONEY	SENSOR	UTILITY
AUDIO	DESK	GATE	MONITOR	SERVICE	VALVE
AUXILIARY	DETECTOR	GLASS	MOTHERS	SHED	VAULT
BABY	DINING	GUEST	MOTION	SHOCK	VIBRATION
BACK	DISCRIMINATOR	GUN	MOTOR	SHOP	VOLTAGE
BAR	DISPLAY	HALL	MUD	SHORT	WALL
BARN	DOCK	HEAT	NORTH	SHOW	WAREHOUSE
BASEMENT	DOOR	HIGH	NURSERY	SIDE	WASH
BATHROOM	DORMER	HOLDUP	OFFICE	SKYLIGHT	WEST
BED	DOWN	HOUSE	OIL	SLIDING	WINDOW
BEDROOM	DOWNSTAIRS	INFRARED	OPEN	SMOKE	WINE
BELL	DRAWER	INSIDE	OPENING	SONIC	WING
BLOWER	DRIVEWAY	INTERIOR	OUTSIDE	SONS	WIRELESS
BOILER	DRUG	INTRUSION	OVERFLOW	SOUTH	WORK
BOTTOM	DUCT	JEWELRY	OVERHEAD	SPRINKLER	XMITTER
BOX	EAST	KITCHEN	PAINTING	STAMP	YARD
BREAK	ELECTRIC	LAUNDRY	PANIC	STATION	ZONE
BUILDING	EMERGENCY	LEFT	PASSIVE	STEREO	0
BURNER	ENTRY	LEVEL	PATIO	STORE	1ST
CABINET	EQUIPMENT	LIBRARY	PERIMETER	STORAGE	2ND
CALL	EXECUTIVE	LIGHT	PHONE	STORY	3RD
CAMERA	EXIT	LINE	PHOTO	STRESS	4TH
CAR	EXTERIOR	LIQUOR	POINT	STRIKE	5TH
CASE	FACTORY	LIVING	POLICE	SUMP	6TH
CASH	FAILURE	LOADING	POOL	SUPERVISED	7TH
CCTV	FAMILY	LOCK	POWER	SUPERVISION	8TH
CEILING	FATHERS	LOOP	QUAD	SWIMMING	9TH
CELLAR	FENCE	LOW	RADIO	SWITCH	
CENTRAL	FILE	LOWER	REAR	TAMPER	
CIRCUIT	FIRE	MACHINE	RECREATION	TAPE	
CLIP	FLOOR		REFRIG	TELCOPHONE	
CLOSED	FLOW			TELLER	
COIN				TEMPERATURE	

*Note: This factory-provided vocabulary of words is subject to change.

VIII. DOWNLOADING PRIMER

WHAT IS DOWNLOADING?

Downloading allows the operator to remotely access, program, and control the security system over normal telephone lines. Anything that can be done directly from the keypad can be done remotely, using DOWNLOADING. To Download, the following is required:

1. An IBM PC, or compatible computer with MS DOS 3.1 or higher, to run the DOWNLOADING program. MS DOS stands for: MicroSoft Disk Operating System.
3. A HAYES 1200 SMARTMODEM (external: level 1.2 or higher; internal: level 1.1 or higher). If these levels cannot be found locally, an external modem can be purchased from ADEMCO, or contact HAYES for a free update. *Other brands are not compatible, even if claimed to be 100% compatible.*
4. 4130PC V-LINK® DOWNLOADING software, from ADEMCO. This software is available in both 3-1/2" (4130P3-3) and 5-1/4" diskettes, and includes a complete User's Manual.

HOW DOES DOWNLOADING WORK?

At the protected premises, the Control panel must be connected to the existing telephone line (refer to the PHONE LINE CONNECTIONS section). No programming of the panel is required before downloading to an initial installation.

To download, do the following:

1. Enter the installer code + [#] + [5]. The panel temporarily enables a ring count of 5 and sets the Download Callback option to "1" (callback not required).
2. Call the panel using the downloader software set to "FIRST COMMUNICATION" mode.
3. The downloader will establish a session with no callback. The panel information can then be downloaded.

In order to remotely access, control, or program the alarm panel, a "link" must be established between the computer and the control panel, as follows:

1. The computer calls up the Control panel. (The phone number for each customer is entered into the customer's account file on the computer).
2. The Control panel "answers" at the pre-programmed ring count and executes a handshake with the computer.
3. The computer sends a request for call-back to the Control, unless call-back is not required.
4. The panel acknowledges the request and hangs up. During the next few seconds, the Control will process the request making sure certain encrypted information, received from the computer, matches its own memory.
5. Upon a successful match, the Control panel will seize the phone line and call the computer back, unless call-back is not required.
6. The computer answers, usually by the second ring, and executes a handshake with the panel.
7. The panel then sends other default information to the computer. If this information matches the computer's information, a successful link is established. This is known as being "ON-LINE".

ADVISORIES:

1. Alarm and trouble responses and reports are disabled during on-line time. Should an event occur during this time, the response will take place and the report will go through as soon as the remote access sequence is completed. Alarm and trouble conditions are not ignored, they are simply delayed.
2. The keypads are inactive during downloading communication, and resume normal functions after hang up. All keypad entries are ignored during on-line time.

WHAT CAN BE DONE ONCE PANEL IS "ON-LINE"?

- Arm the System in the Away Mode; Disarm the System
- Bypass a Zone
- Force the System to Accept a New Program Download
- Shut Down Communication (dialer) Functions (non-payment of monitoring fees in an owned system)
- Shut Down all Security System Functions (non-payment for a leased system)
- Inhibit Local Keypad Programming (prevents takeover of your accounts)
- Leave a message for customer (5137 ONLY)
- Command the System to Upload a Copy of its Resident Program to the office
- Read: Arming Status, AC Power Status, List of Faulted Zones, List of Bypassed Zones, 224 Event Log, List of Zones Currently in Alarm, List of Zones Currently in Trouble, List of RF sensors with low battery conditions
- Set the Real-Time clock.

HOW SECURE IS DOWNLOADING?

Accessing the Control from a remote location is protected against compromise by the use of 4 levels of protection:

1. Security Code Handshake: The subscriber's account number as well as an 8-digit ID number (known only to the office) must be matched between the Control and computer.
2. Hang-Up and Call-Back: The Control panel will "hang-up" and call the computer back at the pre-programmed number only if the security codes match.
3. Data Encryption: All data that is exchanged between the computer and Control is encrypted to reduce the possibility of anyone "tapping" the line and corrupting data.
4. Operator Access Levels: Up to 15 operators can have access to the DOWNLOADER, each having their own log-on code. However, each operator can be assigned one of three levels of access in both FILE and COMMAND functions, as follows:

FILE ACCESS:

Read Only: able only to look at the database; cannot change any information, and cannot see the customer's access codes.

Part Read/Write: able to look at and change all information, except the customer's access codes.

Full Read/Write: able to look at and change any and all information in the database.

CONTROL/COMM ACCESS:

Read Only: able only to Upload and arm the system. Not able to DISARM, BYPASS, or change any information.

Part Read/Write: able to ARM, BYPASS, UPLOAD, DOWNLOAD but cannot shutdown the system.

Full Read/Write: able to perform all control and status commands, as well as shutdown all or part of the system.

NOTES:

1. Each time the Control panel is accessed (whether successful or unsuccessful), a PROGRAM TAMPER report ("40) is sent to central station, if programmed.
2. When downloading, the console will display "MODEM COMM".
3. Whenever a download or a save is done, an automatic time stamp is done, indicating the date and time of the last download (or save) and the operator ID number.
4. The average time for a complete download, including initial call-up, hang-up and call-back is under 4 minutes.
5. A complete hard copy of each individual account can be obtained by connecting a printer to the computer. Refer to your computer owner's manual or contact your dealer for printer recommendations.

IX. TESTING THE SYSTEM

USING TEST MODE

After the installation is completed, the Security System should be thoroughly tested as follows:

1. With the System in the disarmed state, check that all zones are intact. If DISARMED - Press [*] to show faults is displayed, press the [*] key to display the descriptors of the faulted zone(s). Restore faulted zone(s) if necessary, so that ""DISARMED"" READY TO ARM is displayed.
2. Enter the security code and press the TEST key. The external sounder (if used) should sound for 3 seconds and then turn off (the system is operating on the back-up battery only at this time).

NOTE 1. If the sounder does not sound, this may be an indication that the backup battery is discharged or missing.

NOTE 2. As a reminder that the system is in the Test mode, the Console will sound a single beep at 15-second intervals if no protection zones are violated.

NOTE 3. In the Test mode, no alarm reports will be sent to the central station. Also, the external sounder (if used) will not be activated.

Doors and Windows

Open and close each protected door and window in turn. Each action should produce three beeps from the Console. The descriptor for each protection zone will appear on the Console display.

Motion Detectors

Walk in front of any interior motion detectors. Listen for three beeps when the detector senses movement. While it is activated, its descriptor will remain displayed on the Console. Note that wireless PIRs will have a 3 minute lockout between transmissions to conserve battery life (remove cover for walk test to override the 3-minute lock-out).

Smoke Detectors

Follow the test procedure provided by the manufacturer of each smoke detector to ensure that all detectors are operational and are functioning properly.

NOTE: A 2-wire smoke detector display will not clear until the Test mode is exited.

Turning Off TEST mode

Enter the security code and press the OFF key.

ARMED SYSTEM TEST

IMPORTANT! A message will be sent to the central station during the following tests. Notify the central station that a test will be in progress.

NOTE: A display of "COMM. FAILURE" indicates a failure to communicate (no Kissoff by the receiver at the central station after the maximum number of transmission attempts is tried). If this occurs, verify that the phone line is connected, the correct report format is programmed, etc.

1. Arm the system and fault one or more zones. Silence alarm sounder(s) each time by entering the code and pressing OFF. Check that Entry/Exit delay zones provide the assigned delay times.
2. Check the keypad-initiated alarms, if programmed in field *05, by pressing the Panic keys (* and #, 1 and *, and/or 3 and #). If the system has been programmed for audible emergency, the console will emit a loud, steady alarm sound. The word ALARM and a descriptor "99" will be displayed for * and #. (if 1 and * are pressed, a "95" will be displayed; if 3 and # are pressed, a "96" will be displayed). Silence the alarm by entering the security code and pressing OFF. If the system has been programmed for silent panic, there will be no audible alarms or displays. A report will be sent to the central station, however.
3. Notify the central station that all tests are finished and verify results with them.

TURNING THE SYSTEM OVER TO THE USER

1. Fully explain the operation of the system to the user by going over each of its functions as well as the User's Manual supplied.
2. In particular, explain the operation of each zone (entry/exit, perimeter, interior, fire, etc.). Be sure the user understands how to operate any emergency feature(s) programmed into the system.
IMPORTANT! In the spaces provided in the User's Manual, record the Entry and Exit Delay times, and those functions that have been programmed into the available pairs of PANIC keys (* & #, 1 & *, 3 & #).
3. Make sure the user understands the importance of testing the system at least weekly, following the procedure provided in the User's Manual.

UL INSTALLATION REQUIREMENTS

When installing a partitioned system, UL requires that the following be observed:

1. All partitions must be owned and managed by the same person(s).
2. All partitions must be part of one building at one street address.
3. The audible alarm device(s) must be placed where it/they can be heard by all partitions.
4. The Control cabinet itself must be tamper protected and connected to a 24 hour type zone such that any unauthorized access to the control cabinet will cause an alarm.
5. Downloading is not permissible.

TO THE INSTALLER

Regular maintenance and inspection (at least annually) by the installer and frequent testing by the user are vital to continuous satisfactory operation of any alarm system.

The installer should assume the responsibility of developing and offering a regular maintenance program to the user as well as acquainting the user with the proper operation and limitations of the alarm system and its component parts. Recommendations must be included for a specific program of frequent testing (at least weekly) to insure the system's proper operation at all times.

X. TROUBLESHOOTING

CONSOLES

Console is inoperable; erratic display

- Power down completely (AC + battery), disconnect the battery, and power up again (AC only).
- Check that auxiliary voltage is between 12.5VDC-14.0VDC. If not, disconnect all auxiliary devices, and take another reading. If within the above range, there is too much current being drawn by the auxiliary devices. (see the Polling Loop & Auxiliary Device Worksheets for the current draw of each device). If still not within the above range, check incoming power from the No. 1361 transformer. Voltage should be 16.5VAC. If below 15VAC, carefully check the AC supply for a minimum of 110 VAC.
- With all auxiliary devices and battery still disconnected, check the voltage on the red & black battery leads. It should be 13.65VDC (approx.). If not, replace the Control. If it is @ 13.65VDC, the battery may not be at full charge (allow the battery to charge 12-24 hours before reconnecting the auxiliary devices) or the battery may be bad, and not able to hold a charge.

Console displays "Not Ready" but no zone is displayed when the [] ready key is depressed

- Check to make sure there is a zone type response entered in program field *05 for *97 (polling loop short). If no zone response is entered and a loop short occurs, the display will only read "NOT READY", without an explanation.
- Check to determine if a right loop has been enabled for an RPM in a zone expanded system and no zone response is assigned to that sensor loop.
- A zone programmed as a 24 hour silent (type 06) is faulted.

HARD-WIRED ZONES, 1-9

Zone 1 in trouble ("CHECK")

- If programmed for fire or burglary using open-circuit sensors, a 2,000 ohm EOLR must be used across the zone, at the last device, as described in the SYSTEM CONFIGURATION: ZONES section.

Zones 2-8 not detecting faults when their EOLRs are shorted (READY display stays on)

- If using EOLRs, check that program field *41=0; if not using EOLRs, *41=1.

Zone 9 is indicating a fault ("READY" will not appear)

- This zone is for closed circuit, unsupervised use only. Do not use open circuit devices or an EOLR on this zone.

Zone 9 false alarms periodically

- Zone has been programmed for a response time of 5-10 milliseconds (*14), and should be used with "Fast response" devices, such as vibration sensors or glass break sensors, only. If devices with a response time of greater than 10 milliseconds are used, the zone may false alarm due to contact "bounce", if used in areas where vibrations may occur.

Zones 1-9 not detecting faults (READY light stays on)

- Check program fields 1*18 and 1*19 to make sure the wired zone(s) in question have not been enabled as RF zones.

RPMs

Zones indicating "CHECK" conditions

- Check that the DIP switches are set correctly.
- If only left loops are being used, make sure program fields *06, *07, *08, 1*10, 1*11, 1*12, and 1*13 are programmed as "0".
- If both left and right loops are being used, make sure program fields *06, *07, *08, 1*10, 1*11, 1*12, and 1*13 are programmed with "0"s for the left loops and "1"s for the right loops. NOTE: On a 4190WH you cannot use a right loop unless the left loop is used also.
- Check polling loop voltage at the control as well as at each RPM. There should be fluctuating 8-11VDC on the loop.
- Check if programmed for tamper detection in program field *24. If *24 = 0, the RPM will come up in trouble when its cover is removed (4190WH only).
- If a 4208 is being used for zones 10-17, program field *86 must be set for "1", and the DIP switches should be set as follows: 1,2,3,4,=ON, 5=OFF. If any other 4208 configuration is being used, field *86 must = "0" and the DIP switches set according to the instructions accompanying the 4208.

Zones indicating fault conditions ("READY" not displayed)

- If using a 4190WH, make sure that the jumpers are set up in accordance with the EOLR being used on the left loop (the right loop never uses an EOLR). See the 4190WH WIRING DIAGRAM in the SPECIFICATIONS section for proper use of these jumpers and EOLRs.
- If using a 4208, make sure the zones are set up with the correct EOLRs. See the SYSTEM CONFIGURATION: ZONES section for 4208 usage.
- If using a 4196 right loop, make sure only closed-circuit devices are used, and check the program fields *06 through *08, and 1*10 through 1*13 to make sure the zones in question are enabled as right loops ("1").

"97" appears in console display with rapid beeping

- This indicates that a "short" has been detected on the polling loop.
- Check that polling loop polarity is correct at the control as well as at each RPM.
- Disconnect the polling loop and check for continuity from the positive (+) side of the loop to ground. There should be no continuity to ground. If there is a ground, the source must be found and eliminated.

"READY" display not going out when zones faulted

- Check program fields 1*19 through 1*25 to make sure that the zones in question are not enabled as RF zones.
- Make sure each zone in question has been programmed for a response in fields *02-*05 and 1*01-1*05.

Console displays "NOT READY" but no zone is displayed when [] READY key is depressed

- Check program fields *06 through *08, and 1*10 through 1*13 to make sure that right loops are enabled for the correct zones. If no right loops are being used, these fields should = "0".
- Check program field *05 to make sure there is a zone type response entered for *97. If a polling loop short occurs and no response is entered for *97, the display would indicate "NOT READY" with no explanation.
- A point programmed for 24 hour silent (type 06) is faulted.

WIRELESS

"88" or "90" appears in console display and rapid beeping occurs

- The receiver is not receiving any signals from any of the transmitters in the system. An "88" is for the 2nd receiver; a "90" is for the 1st receiver. These displays are enabled by assigning a zone response type in program field 1*09.
- Check that the antenna is installed properly and is not shorted to any metal object, refer to WIRELESS EXPANSION section for details.
- Check that the transmitters are powered up with fresh 9 volt batteries.
- Check that the house ID's match between transmitters and the receiver.
- Determine if anything is blocking transmission to the receiver (ex: metal cabinets or shelves, etc.)
- If 4280 is used, remove its cover. Put the system in the test mode, then see if the transmitters check-in. If not, move the receiver to another location and test again.

"89" or "91" appears in console display and rapid beeping occurs

- The receiver is not responding to the Control panel. An "89" refers to the second receiver and a "91" refers to the first receiver.
- If 4280 is used, check that the 4280's cover is on and the magnet is in close proximity to the reed switch.
- Check that the control is wired properly to the receiver.
- If 4280 is used, determine that the total current draw on the polling loop is not more than 64mA. If the draw does exceed 64mA, install a 4197 loop extender module, or power the 4280 from auxiliary power, as described.
- Check that the wire run length is in agreement with the recommended wire gauge.

Zones, not programmed in the system, are indicating "CHECK" conditions

- Check program fields *02 through *05, and 1*01 through 1*05 to make sure all unused zones are 00s.
- Check program fields 1*18 through 1*25 to make sure that all non-RF zones are 0s.

Zones indicating "NOT READY" condition, but transmitter contact loop is intact

- Put the system in the SNIFFER MODE for at least 2 hours, to see if another system in the area is using the same house ID. If so, change this system's house ID number.
- Make sure zones in question are selected as RF in fields 1*18-1*25.

One or more transmitters are indicating "CHECK" conditions after a while; console beeping rapidly:

- Check that the transmitters have the correct house ID programmed.
- Check that the transmitters have the correct transmitter ID assigned.
- Check that the transmitters have fresh batteries.

"97" appears in the console display and rapid beeping occurs

- This indicates that the polling loop has either a direct short, or a short to ground on the (+) side. Might also indicate that the 4280 RF Receiver is causing the short (disconnect 4280 to verify).
- Check that polling loop polarity is correct at the Control panel, as well as at each 4280.
- Check continuity from (+) side of the loop to ground (disconnect the polling loop from the Control first!) - an open should be read (no continuity). If a short to ground exists, find and eliminate the short.
- Check voltage across the polling loop at the Control panel as well as at each 4280, if used - there should be fluctuation between 8-11VDC.

"READY" display not going out when RF zones faulted

- Check that the house ID's match between the transmitters and the receiver.
- Check that the receiver is enabled in program fields 1*26 for the first receiver and 1*27 for the second receiver.
- Check that the zones in question are enabled for RF in program fields 1*18 through 1*25.
- Check that a zone response is programmed for the zones in question, in fields *02 through *05, and 1*01 through 1*05.
- Check that the receiver's antenna is properly installed.
- Remove any sensors from the transmitters and short across the transmitter terminals. Then fault the transmitter to see if the "READY" light goes out. If it does not go out, check the programming for that particular transmitter; if it does go out, check the sensors on that zone.
- Move the receiver to another location for better reception.

Console displays "NOT READY" but no zone is displayed when [] READY key is depressed

- Check program field *05 to make sure "97" has a zone type response entered. If a loop short occurs and no response is entered for "97", the console would display only "NOT READY", with no explanation.
- A Silent Panic condition may be present. Key the security code + OFF to see if the condition clears.

While in the "TEST" mode, some or all of the transmitters are not responding, or are responding irregularly

- The Test mode cuts the receiver's sensitivity by 50%. This means that as long as a transmitter responds, its location is satisfactory.
- Move the affected transmitters to another location and re-test. There may be something blocking its transmission path.
- If all transmitters are affected, move the receiver to another location. There may be something blocking its reception.
- If no receiver location can be found that can reliably receive all transmitters, add a second receiver in a different location in the premises to extend the RF coverage of the system.

COMMUNICATIONS

"COMM FAILURE" is displayed

- "COMM FAILURE" (5137AD) indicates that the communicator has attempted 8 times to send a report to the central station but did not get kissoff.
- Check with the central station to make sure the programmed format is acceptable to the central station's receiver.
- Check program field *49 to see if single message with checksum has been enabled. The central station receiver might not be able to handle checksum.
- Check program field 1*34 to see if split reporting is enabled. If only a primary central station phone number is being used, field 1*34 must = 0!
- Check program field *31, PABX ACCESS CODE. Enter up to 4-digits only if an outside line must be accessed before the number is dialed or if "call waiting" is to be suppressed. The latter feature must be obtained from the local telephone company. To make sure this field is empty, key *31* to erase this location.
- Check program field *30 for either TouchTone or rotary dialing. In most cases, if rotary is selected dialing will be successful, but if TouchTone is selected, then the line must be a TouchTone line. It is possible that a line that had permitted TouchTone service previously was now being blocked from that use by the telephone company because the user was not paying for that service. At installation time, it is important to check with the user to determine if they are paying for TouchTone service.
- If SESCO/RADIONICS format is being used, check program field *50. If hexadecimal codes are being sent, enter a "0". If only 0-9 is being sent, either a "1" or a "0" is acceptable. Check with the central station to verify acceptance of B-F codes.
- If 3+1/4+1 LOW SPEED is being used, check the ID portion of the report code fields. There should be "0" in all of these fields. Some central station receivers cannot handle second digit reporting.
- Check the telephone numbers programmed in fields *33 & *34.
- Listen to the outgoing call attempts using a handset.
- Check the wiring on the Telco connector.

XI. SPECIFICATIONS

4140XMPT CONTROL

Physical: 12-1/2"W X 14-1/2"H X 3"D

Electrical:

VOLTAGE INPUT: From Ademco No. 1361 Plug-in Transformer (use 1361CN in Canada) rated 16.5VAC, 40 VA.

ALARM SOUNDER OUTPUT: 10VDC-13.8VDC, 2.8 amps max. (non-UL installations), 750mA less aux. current draw (UL installations).

AUXILIARY POWER OUTPUT: 9.6VDC-13.8VDC, 750mA max. For UL installations, the accessories connected to the output must be UL Listed, and rated to operate in the above voltage range.

BACK-UP BATTERY: 12VDC, 4AH or 7AH gel cell. YUASA NP4-12 (12V, 4AH) or NP7-12 (12V, 7AH) recommended. Use 4AH battery for UL installations.

STANDBY: 4 hours min. with 750 mA aux. load using 6 AH battery.

CIRCUIT PROTECTORS: Thermal circuit breakers are used on battery input to protect against reverse battery connections and on alarm sounder output to protect against wiring faults (Shorts). A solid state circuit breaker is used on auxiliary power output to protect against wiring faults (shorts).

DIGITAL COMMUNICATOR

FORMATS SUPPORTED:

ADEMCO HIGH SPEED
 ADEMCO 4+2 EXPRESS
 ADEMCO LOW SPEED
 ADEMCO CONTACT ID
 SESCOA
 RADIONICS LOW SPEED
 LINE SEIZE: Double Pole
 RINGER EQUIVALENCE: 0.7B
 FCC REGISTRATION NO.: AC398U-68192-AL-E

5137AD REMOTE CONSOLES

Physical: Width: 8.4 inches
 Height: 4.75 inches
 Depth: 1.1 inches

Electrical: Voltage Input: 12VDC
 Current Drain: 90 mA (5137AD with backlighting)

Interface Wiring:

RED: 12VDC input (+) auxiliary power
 BLUE: Not Used
 GREEN: Data In
 YELLOW: Data Out
 BLACK: Ground and (-) connection from supplemental power supply.

4190WH OPERATION & WIRING DIAGRAM

The 4190WH is a 2-zone (known as left and right loops) RPM. The left loop can be used for closed-circuit devices, with or without EOLR supervision, and for open-circuit devices, with EOLR supervision. The left loop can also be used with fast-response (10 millisecond) devices, if necessary. Follow the chart for cutting the correct jumpers and choosing the correct resistor when using the left loop.

The right loop is for closed-circuit, unsupervised use only, and has a response time of 400 milliseconds. The jumpers do not affect the right loop in any way. Do not use a resistor on this loop. Note that the right loop can only be used if the left loop is also used, and that the right loop numerically follows the left loop's zone number, which is set with the unit's DIP switches (ex. if left loop is zone 12, right loop is zone 13).

IMPORTANT: The tamper/supervision response of the 4190WH is determined by the zone response type assigned to the left loop (even if the right loop is assigned a different response type). While the system is disarmed, tamper/supervisory faults will always report as trouble messages. While the system is armed, tamper/supervisory faults will report as troubles if the left loop is assigned a non-burglary response type (i.e. fire, panic, aux), and will report as alarms if assigned a burglary response type.

JUMPERS	USAGE (LEFT ZONE ONLY)
RED	Cut for fast-response (10 millisecond).
WHITE	Cut for low current mode (reed type switches); use the 30,000 ohm resistor, provided. Must be cut if BLUE jumper is cut. 4190WH draws 1 mA from the polling loop in this mode.
BLUE	Cut for use with no EOLR (closed-circuit only). Doing this automatically puts an internal 30,000 ohm resistor in series with the zone, so the white jumper must also be cut.
NONE CUT	High current mode: Use the 4,700 ohm resistor, provided, with mechanical switches in either an open-circuit or closed-circuit configuration. 4190WH draws 2 mA from the polling loop in this mode.

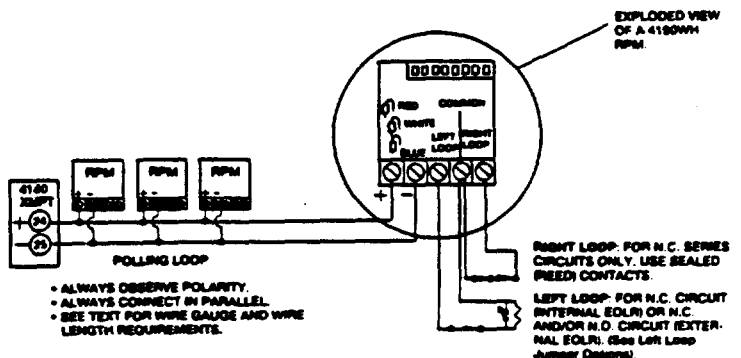

279

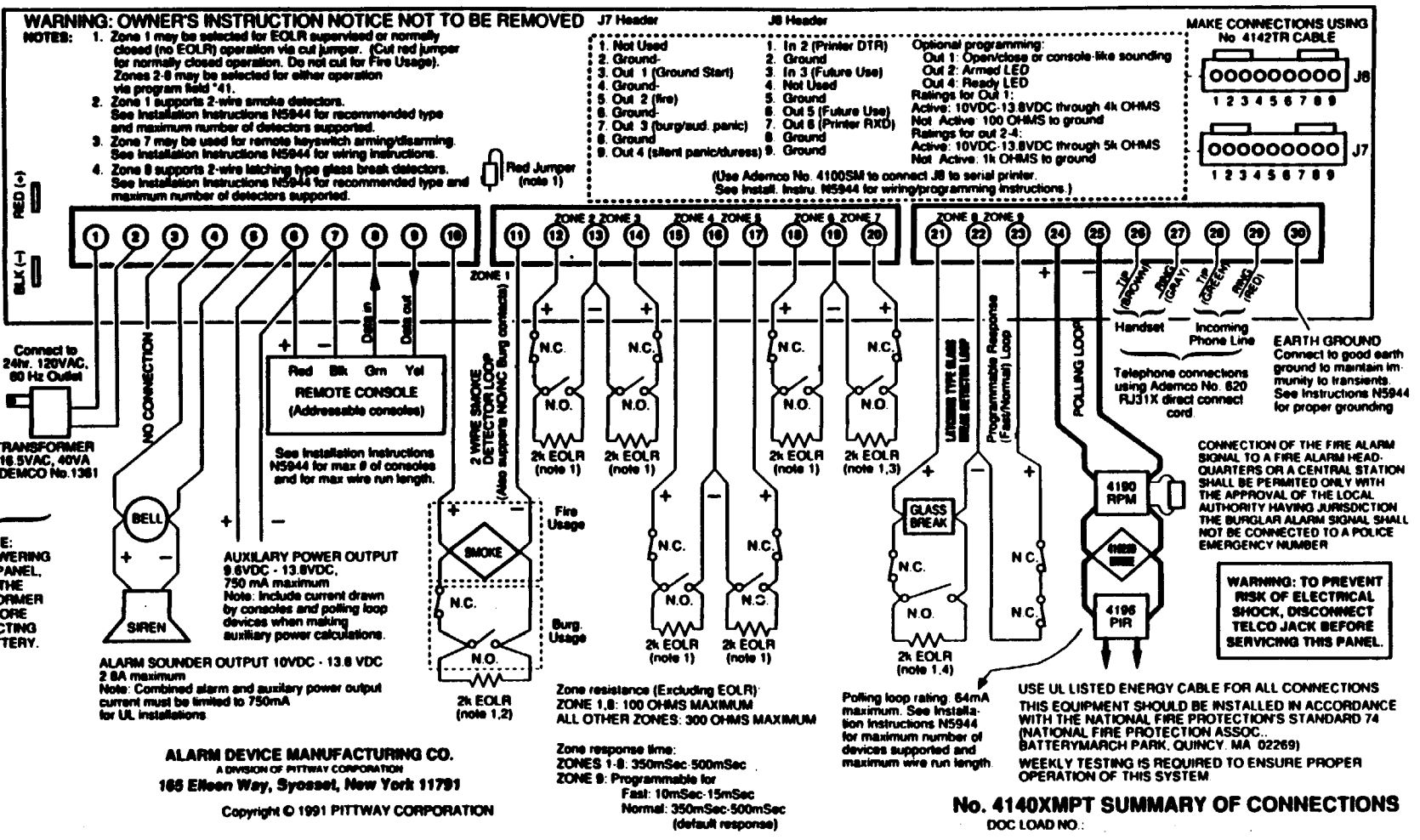

NS945 8/91

Copyright © 1991 PITTMAY CORPORATION

No. 4140XMPT SUMMARY OF CONNECTIONS
 DOC LOAD NO.:

DIP SWITCH TABLES FOR ADDRESSABLE CONSOLES AND POLLING LOOP DEVICES

Addressable Consoles (e.g. 5137AD)

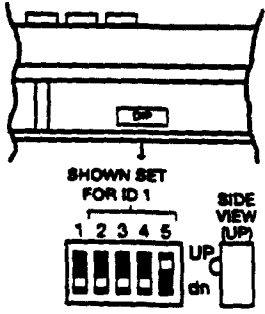

SHOWN SET FOR ID 1
1 2 3 4 5
SIDE VIEW (UP)
UP
DN

↑ IMPORTANT: USE ID 31 FOR APPLICATIONS NOT REQUIRING ADDRESSABLE CONSOLES.

4208 Zone Expander



SHOWN SET FOR ID 10-18 (A)
1 2 3 4 5
SIDE VIEW (UP)
UP
DN
POS. 1: LOOPS 1 & 2 RESPONSE TIME:
W/TABLE FAST SLOW
A UP DN
B DN UP

4192SD/4192SDT/ 4192CP Smoke Detectors

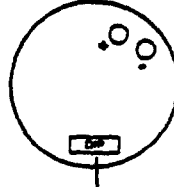

APPLIES TO TABLE A ONLY
SHOWN SET FOR ID 10
1 2 3 4 5 6 7 8
SIDE VIEW (UP)
SIDE VIEW (DN)
↑ POS. 1: MUST BE DN

4190WH Zone Expander

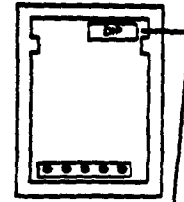

APPLIES TO TABLES A & B
SHOWN SET FOR ID 10(A)
1 2 3 4 5 6 7 8
UP
DN
SIDE VIEW (DN)
↑ WITH TABLE: A B
POS. 1 MUST BE: DN UP

DEVICE ID	DIP SWITCH POSITION				
	1	2	3	4	5
0	dn	dn	dn	dn	dn
1	dn	dn	dn	UP	dn
2	dn	dn	dn	UP	UP
3	dn	dn	dn	UP	UP
4	dn	dn	UP	dn	dn
5	dn	dn	UP	dn	UP
6	dn	dn	UP	dn	UP
7	dn	dn	UP	UP	dn
8	dn	UP	dn	dn	dn
9	dn	UP	dn	dn	UP
10	dn	UP	dn	UP	dn
11	dn	UP	dn	UP	UP
12	dn	UP	dn	UP	dn
13	dn	UP	dn	UP	UP
14	dn	UP	dn	UP	dn
15	dn	UP	dn	UP	UP
16	UP	dn	dn	dn	dn
17	UP	dn	dn	dn	UP
18	UP	dn	dn	dn	UP
19	UP	dn	dn	UP	UP
20	UP	dn	dn	UP	dn
21	UP	dn	dn	UP	UP
22	UP	dn	UP	dn	dn
23	UP	dn	UP	dn	UP
24	UP	UP	dn	dn	dn
25	UP	UP	dn	dn	UP
26	UP	UP	dn	dn	UP
27	UP	UP	dn	UP	dn
28	UP	UP	dn	UP	UP
29	UP	UP	dn	UP	dn
30	UP	UP	dn	UP	UP
31	UP	UP	UP	UP	UP
BIT VALUE:	16	8	4	2	1

THIS TABLE FOR DIPS WITH WORD "OFF" A

DEVICE ID	DIP SWITCH POSITION				
	2	3	4	5	
10-16	dn	dn	dn	UP	
17-24	dn	dn	dn	UP	dn
25-32	dn	dn	dn	UP	UP
33-40	dn	UP	dn	dn	
41-48	dn	UP	dn	UP	
49-56	dn	UP	dn	UP	dn
57-64	dn	UP	dn	UP	UP

THIS TABLE FOR DIPS WITH WORD "ON" B

DEVICE ID	DIP SWITCH POSITION				
	2	3	4	5	
10-16	UP	UP	UP	dn	
17-24	UP	UP	dn	dn	
25-32	UP	UP	dn	dn	dn
33-40	UP	dn	dn	dn	
41-48	UP	dn	dn	UP	
49-56	UP	dn	dn	UP	dn
57-64	UP	dn	dn	UP	UP

THIS TABLE FOR DIPS WITH WORD "OFF" A

DEVICE ID	DIP SWITCH POSITION							
	2	3	4	5	6	7	8	
10	dn	dn	dn	UP	dn	UP	dn	
11	dn	dn	dn	UP	dn	UP	UP	
12	dn	dn	dn	UP	UP	dn	UP	
13	dn	dn	dn	UP	UP	dn	UP	
14	dn	dn	dn	UP	UP	UP	dn	
15	dn	dn	dn	UP	UP	UP	UP	
16	dn	dn	UP	dn	dn	dn	dn	
17	dn	dn	UP	dn	dn	dn	UP	
18	dn	dn	UP	dn	dn	UP	dn	
19	dn	dn	UP	dn	dn	UP	UP	
20	dn	dn	UP	dn	UP	dn	dn	
21	dn	dn	UP	dn	UP	dn	UP	
22	dn	dn	UP	dn	UP	dn	UP	
23	dn	dn	UP	dn	UP	dn	UP	
24	dn	dn	UP	dn	UP	dn	UP	
25	dn	dn	UP	dn	UP	dn	UP	
26	dn	dn	UP	dn	UP	dn	UP	
27	dn	dn	UP	dn	UP	dn	UP	
28	dn	dn	UP	dn	UP	dn	UP	
29	dn	dn	UP	dn	UP	dn	UP	
30	dn	dn	UP	dn	UP	dn	UP	
31	dn	dn	UP	dn	UP	dn	UP	
32	dn	dn	UP	dn	UP	dn	UP	
33	dn	dn	UP	dn	UP	dn	UP	
34	dn	dn	UP	dn	UP	dn	UP	
35	dn	dn	UP	dn	UP	dn	UP	
36	dn	dn	UP	dn	UP	dn	UP	
37	dn	dn	UP	dn	UP	dn	UP	
38	dn	dn	UP	dn	UP	dn	UP	
39	dn	dn	UP	dn	UP	dn	UP	
40	dn	dn	UP	dn	UP	dn	UP	
41	dn	dn	UP	dn	UP	dn	UP	
42	dn	dn	UP	dn	UP	dn	UP	
43	dn	dn	UP	dn	UP	dn	UP	
44	dn	dn	UP	dn	UP	dn	UP	
45	dn	dn	UP	dn	UP	dn	UP	
46	dn	dn	UP	dn	UP	dn	UP	
47	dn	dn	UP	dn	UP	dn	UP	
48	dn	dn	UP	dn	UP	dn	UP	
49	dn	dn	UP	dn	UP	dn	UP	
50	dn	dn	UP	dn	UP	dn	UP	
51	dn	dn	UP	dn	UP	dn	UP	
52	dn	dn	UP	dn	UP	dn	UP	
53	dn	dn	UP	dn	UP	dn	UP	
54	dn	dn	UP	dn	UP	dn	UP	
BIT VALUE:	64	32	16	8	4	2	1	

THIS TABLE FOR DIPS WITH WORD "ON" B

DEVICE ID	DIP SWITCH POSITION							
	2	3	4	5	6	7	8	
10	UP	UP	UP	dn	UP	dn	UP	
11	UP	UP	UP	dn	UP	dn	UP	
12	UP	UP	UP	dn	UP	dn	UP	
13	UP	UP	UP	dn	UP	dn	UP	
14	UP	UP	UP	dn	UP	dn	UP	
15	UP	UP	UP	dn	UP	dn	UP	
16	UP	UP	UP	dn	UP	UP	UP	
17	UP	UP	UP	dn	UP	UP	UP	
18	UP	UP	UP	dn	UP	UP	UP	
19	UP	UP	UP	dn	UP	UP	UP	
20	UP	UP	UP	dn	UP	UP	UP	
21	UP	UP	UP	dn	UP	UP	UP	
22	UP	UP	UP	dn	UP	UP	UP	
23	UP	UP	UP	dn	UP	UP	UP	
24	UP	UP	UP	dn	UP	UP	UP	
25	UP	UP	UP	dn	UP	UP	UP	
26	UP	UP	UP	dn	UP	UP	UP	
27	UP	UP	UP	dn	UP	UP	UP	
28	UP	UP	UP	dn	UP	UP	UP	
29	UP	UP	UP	dn	UP	UP	UP	
30	UP	UP	UP	dn	UP	UP	UP	
31	UP	UP	UP	dn	UP	UP	UP	
32	UP	UP	UP	dn	UP	UP	UP	
33	UP	UP	UP	dn	UP	UP	UP	
34	UP	UP	UP	dn	UP	UP	UP	
35	UP	UP	UP	dn	UP	UP	UP	
36	UP	UP	UP	dn	UP	UP	UP	
37	UP	UP	UP	dn	UP	UP	UP	
38	UP	UP	UP	dn	UP	UP	UP	
39	UP	UP	UP	dn	UP	UP	UP	
40	UP	UP	UP	dn	UP	UP	UP	
41	UP	UP	UP	dn	UP	UP	UP	
42	UP	UP	UP	dn	UP	UP	UP	
43	UP	UP	UP	dn	UP	UP	UP	
44	UP	UP	UP	dn	UP	UP	UP	
45	UP	UP	UP	dn	UP	UP	UP	
46	UP	UP	UP	dn	UP	UP	UP	
47	UP	UP	UP	dn	UP	UP	UP	
48	UP	UP	UP	dn	UP	UP	UP	
49	UP	UP	UP	dn	UP	UP	UP	
50	UP	UP	UP	dn	UP	UP	UP	
51	UP	UP	UP	dn	UP	UP	UP	
52	UP	UP	UP	dn	UP	UP	UP	
53	UP	UP	UP	dn	UP	UP	UP	
54	UP	UP	UP	dn	UP	UP	UP	
BIT VALUE:	64	32	16	8	4	2	1	

DIP SWITCH TABLES FOR POLLING LOOP DEVICES

4196 PIR



POS. 1: MUST BE UP

4275 PIR

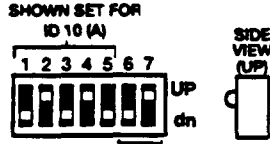
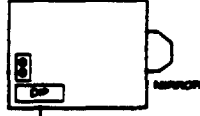

POS. 6: UP (A), dn (B) = INST. MODE
dn (A), UP (B) = PULSE COUNT
POS. 7: UP (A), dn (B) = WALK TEST
dn (A), UP (B) = W/T DISABLE

4278 PIR

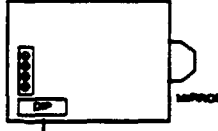

POS. 7: UP = NORMAL MODE
dn = INSTANT MODE
POS. 8: UP = W/T DISABLE
dn = WALK TEST

4194 Reed Contact (Surface Mount)

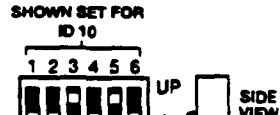

DEVICE ID	DIP SWITCH POSITION							
	2	3	4	5	6	7	8	
10	UP	UP	UP	dn	UP	dn	UP	
11	UP	UP	UP	dn	UP	dn	dn	
12	UP	UP	UP	dn	dn	UP	UP	
13	UP	UP	UP	dn	dn	dn	UP	
14	UP	UP	UP	dn	dn	dn	dn	
15	UP	UP	UP	dn	dn	dn	dn	
16	UP	UP	UP	dn	dn	dn	dn	
17	UP	UP	UP	dn	dn	dn	dn	
18	UP	UP	UP	dn	dn	dn	dn	
19	UP	UP	UP	dn	dn	dn	dn	
20	UP	UP	UP	dn	dn	dn	dn	
21	UP	UP	UP	dn	dn	dn	dn	
22	UP	UP	UP	dn	dn	dn	dn	
23	UP	UP	UP	dn	dn	dn	dn	
24	UP	UP	UP	dn	dn	dn	dn	
25	UP	UP	UP	dn	dn	dn	dn	
26	UP	UP	UP	dn	dn	dn	dn	
27	UP	UP	UP	dn	dn	dn	dn	
28	UP	UP	UP	dn	dn	dn	dn	
29	UP	UP	UP	dn	dn	dn	dn	
30	UP	UP	UP	dn	dn	dn	dn	
31	UP	UP	UP	dn	dn	dn	dn	
32	UP	UP	UP	dn	dn	dn	dn	
33	UP	UP	UP	dn	dn	dn	dn	
34	UP	UP	UP	dn	dn	dn	dn	
35	UP	UP	UP	dn	dn	dn	dn	
36	UP	UP	UP	dn	dn	dn	dn	
37	UP	UP	UP	dn	dn	dn	dn	
38	UP	UP	UP	dn	dn	dn	dn	
39	UP	UP	UP	dn	dn	dn	dn	
40	UP	UP	UP	dn	dn	dn	dn	
41	UP	UP	UP	dn	dn	dn	dn	
42	UP	UP	UP	dn	dn	dn	dn	
43	UP	UP	UP	dn	dn	dn	dn	
44	UP	UP	UP	dn	dn	dn	dn	
45	UP	UP	UP	dn	dn	dn	dn	
46	UP	UP	UP	dn	dn	dn	dn	
47	UP	UP	UP	dn	dn	dn	dn	
48	UP	UP	UP	dn	dn	dn	dn	
49	UP	UP	UP	dn	dn	dn	dn	
50	UP	UP	UP	dn	dn	dn	dn	
51	UP	UP	UP	dn	dn	dn	dn	
52	UP	UP	UP	dn	dn	dn	dn	
53	UP	UP	UP	dn	dn	dn	dn	
54	UP	UP	UP	dn	dn	dn	dn	
55	UP	UP	UP	dn	dn	dn	dn	
56	UP	UP	UP	dn	dn	dn	dn	
57	UP	UP	UP	dn	dn	dn	dn	
58	UP	UP	UP	dn	dn	dn	dn	
59	UP	UP	UP	dn	dn	dn	dn	
60	UP	UP	UP	dn	dn	dn	dn	
61	UP	UP	UP	dn	dn	dn	dn	
62	UP	UP	UP	dn	dn	dn	dn	
63	UP	UP	UP	dn	dn	dn	dn	
64	UP	UP	UP	dn	dn	dn	dn	
BIT VALUE:	64	32	16	8	4	2	1	

THIS TABLE FOR DIPS WITH WORD "OFF" A

DEVICE ID	DIP SWITCH POSITION				
	1	2	3	4	5
10	dn	UP	dn	UP	dn
11	dn	UP	dn	UP	UP
12	dn	UP	dn	dn	UP
13	dn	UP	dn	dn	dn
14	dn	UP	dn	dn	dn
15	dn	UP	dn	dn	dn
16	dn	UP	dn	dn	dn
17	dn	UP	dn	dn	dn
18	dn	UP	dn	dn	dn
19	dn	UP	dn	dn	dn
20	dn	UP	dn	dn	dn
21	dn	UP	dn	dn	dn
22	dn	UP	dn	dn	dn
23	dn	UP	dn	dn	dn
24	dn	UP	dn	dn	dn
25	dn	UP	dn	dn	dn
26	dn	UP	dn	dn	dn
27	dn	UP	dn	dn	dn
28	dn	UP	dn	dn	dn
29	dn	UP	dn	dn	dn
30	dn	UP	dn	dn	dn
31	dn	UP	dn	dn	dn
BIT VALUE:	16	8	4	2	1

THIS TABLE FOR DIPS WITH WORD "ON" B

DEVICE ID	DIP SWITCH POSITION				
	1	2	3	4	5
10	UP	dn	UP	dn	UP
11	UP	dn	UP	dn	dn
12	UP	dn	dn	UP	UP
13	UP	dn	dn	dn	UP
14	UP	dn	dn	dn	dn
15	UP	dn	dn	dn	dn
16	UP	dn	dn	dn	dn
17	UP	dn	dn	dn	dn
18	UP	dn	dn	dn	dn
19	UP	dn	dn	dn	dn
20	UP	dn	dn	dn	dn
21	UP	dn	dn	dn	dn
22	UP	dn	dn	dn	dn
23	UP	dn	dn	dn	dn
24	UP	dn	dn	dn	dn
25	UP	dn	dn	dn	dn
26	UP	dn	dn	dn	dn
27	UP	dn	dn	dn	dn
28	UP	dn	dn	dn	dn
29	UP	dn	dn	dn	dn
30	UP	dn	dn	dn	dn
31	UP	dn	dn	dn	dn
BIT VALUE:	16	8	4	2	1

DEVICE ID	DIP SWITCH POSITION					
	1	2	3	4	5	6
10	UP	UP	dn	UP	dn	UP
11	UP	UP	dn	UP	dn	dn
12	UP	UP	dn	dn	UP	UP
13	UP	UP	dn	dn	dn	UP
14	UP	UP	dn	dn	dn	dn
15	UP	UP	dn	dn	dn	dn
16	UP	UP	dn	dn	dn	dn
17	UP	UP	dn	dn	dn	dn
18	UP	UP	dn	dn	dn	dn
19	UP	UP	dn	dn	dn	dn
20	UP	UP	dn	dn	dn	dn
21	UP	UP	dn	dn	dn	dn
22	UP	UP	dn	dn	dn	dn
23	UP	UP	dn	dn	dn	dn
24	UP	UP	dn	dn	dn	dn
25	UP	UP	dn	dn	dn	dn
26	UP	UP	dn	dn	dn	dn
27	UP	UP	dn	dn	dn	dn
28	UP	UP	dn	dn	dn	dn
29	UP	UP	dn	dn	dn	dn
30	UP	UP	dn	dn	dn	dn
31	UP	UP	dn	dn	dn	dn
32	UP	UP	dn	dn	dn	dn
33	UP	UP	dn	dn	dn	dn
34	UP	UP	dn	dn	dn	dn
35	UP	UP	dn	dn	dn	dn
36	UP	UP	dn	dn	dn	dn
37	UP	UP	dn	dn	dn	dn
38	UP	UP	dn	dn	dn	dn
39	UP	UP	dn	dn	dn	dn
40	UP	UP	dn	dn	dn	dn
41	UP	UP	dn	dn	dn	dn
42	UP	UP	dn	dn	dn	dn
43	UP	UP	dn	dn	dn	dn
44	UP	UP	dn	dn	dn	dn
45	UP	UP	dn	dn	dn	dn
46	UP	UP	dn	dn	dn	dn
47	UP	UP	dn	dn	dn	dn
48	UP	UP	dn	dn	dn	dn
49	UP	UP	dn	dn	dn	dn
50	UP	UP	dn	dn	dn	dn
51	UP	UP	dn	dn	dn	dn
52	UP	UP	dn	dn	dn	dn
53	UP	UP	dn	dn	dn	dn
54	UP	UP	dn	dn	dn	dn
55	UP	UP	dn	dn	dn	dn
56	UP	UP	dn	dn	dn	dn
57	UP	UP	dn	dn	dn	dn
58	UP	UP	dn	dn	dn	dn
59	UP	UP	dn	dn	dn	dn
60	UP	UP	dn	dn	dn	dn
61	UP	UP	dn	dn	dn	dn
62	UP	UP	dn	dn	dn	dn
63	UP	UP	dn	dn	dn	dn
BIT VALUE:	32	16	8	4	2	1

DEVICE ID	DIP SWITCH POSITION					
	1	2	3	4	5	6
10	dn	dn	UP	dn	UP	dn
11	dn	dn	UP	dn	UP	UP
12	dn	dn	UP	dn	dn	UP
13	dn	dn	UP	dn	dn	dn
14	dn	dn	UP	dn	dn	dn
15	dn	dn	UP	dn	dn	dn
16	dn	dn	UP	dn	dn	dn
17	dn	dn	UP	dn	dn	dn
18	dn	dn	UP	dn	dn	dn
19	dn	dn	UP	dn	dn	dn
20	dn	dn	UP	dn	dn	dn
21	dn	dn	UP	dn	dn	dn
22	dn	dn	UP	dn	dn	dn
23	dn	dn	UP	dn	dn	dn
24	dn	dn	UP	dn	dn	dn
25	dn	dn	UP	dn	dn	dn
26	dn	dn	UP	dn	dn	dn
27	dn	dn	UP	dn	dn	dn
28	dn	dn	UP	dn	dn	dn
29	dn	dn	UP	dn	dn	dn
30	dn	dn	UP	dn	dn	dn
31	dn	dn	UP	dn	dn	dn
32	dn	dn	UP	dn	dn	dn
33	dn	dn	UP	dn	dn	dn
34	dn	dn	UP	dn	dn	dn
35	dn	dn	UP	dn	dn	dn
36	dn	dn	UP	dn	dn	dn
37	dn	dn	UP	dn	dn	dn
38	dn	dn	UP	dn	dn	dn
39	dn	dn	UP	dn	dn	dn
40	dn	dn	UP	dn	dn	dn
41	dn	dn	UP	dn	dn	dn
42	dn	dn	UP	dn	dn	dn
43	dn	dn	UP	dn	dn	dn
44	dn	dn	UP	dn	dn	dn
45	dn	dn	UP	dn	dn	dn
46	dn	dn	UP	dn	dn	dn
47	dn	dn	UP	dn	dn	dn
48	dn	dn	UP	dn	dn	dn
49	dn	dn	UP	dn	dn	dn
50	dn	dn	UP	dn	dn	dn
51	dn	dn	UP	dn	dn	dn
52	dn	dn	UP	dn	dn	dn
53	dn	dn	UP	dn	dn	dn
54	dn	dn	UP	dn	dn	dn
55	dn	dn	UP	dn	dn	dn
56	dn	dn	UP	dn	dn	dn
57	dn	dn	UP	dn	dn	dn
58	dn	dn	UP	dn	dn	dn
59	dn	dn	UP	dn	dn	dn
60	dn	dn	UP	dn	dn	dn
61	dn	dn	UP	dn	dn	dn
62	dn	dn	UP	dn	dn	dn
63	dn	dn	UP	dn	dn	dn
BIT VALUE:	32	16	8	4	2	1

DIP SWITCH TABLES FOR WIRELESS DEVICES

House ID Switch Setting for All Devices Except 5716

HOUSE ID	1	2	3	4	5
1	UP	UP	UP	UP	dn
2	UP	UP	UP	dn	UP
3	UP	UP	dn	UP	UP
4	UP	UP	dn	dn	UP
5	UP	UP	dn	dn	dn
6	UP	dn	UP	UP	UP
7	UP	dn	UP	dn	UP
8	UP	dn	UP	dn	dn
9	UP	dn	dn	UP	UP
10	UP	dn	dn	UP	dn
11	UP	dn	dn	dn	UP
12	UP	dn	dn	dn	dn
13	dn	UP	UP	UP	UP
14	dn	UP	UP	dn	UP
15	dn	UP	UP	dn	dn
16	dn	UP	dn	UP	UP
17	dn	UP	dn	dn	UP
18	dn	UP	dn	dn	dn
19	dn	dn	UP	UP	UP
20	dn	dn	UP	dn	UP
21	dn	dn	UP	dn	dn
22	dn	dn	dn	UP	UP
23	dn	dn	dn	UP	dn
24	dn	dn	dn	dn	UP
25	dn	dn	dn	dn	dn
26	dn	dn	dn	dn	dn
27	dn	dn	dn	dn	dn
28	dn	dn	dn	dn	dn
29	dn	dn	dn	dn	dn
30	dn	dn	dn	dn	dn
31	dn	dn	dn	dn	dn

SET VALUE: 18 8 4 2 1

5701 Panic Xmtr.

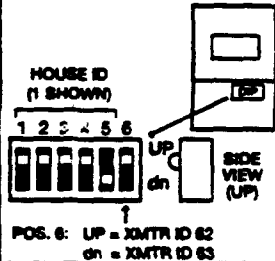

5727 Keypad

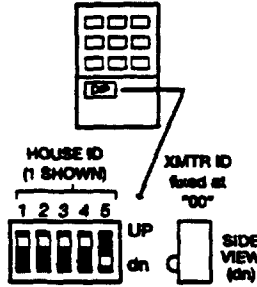

5706 Smoke Detector/Transmitter

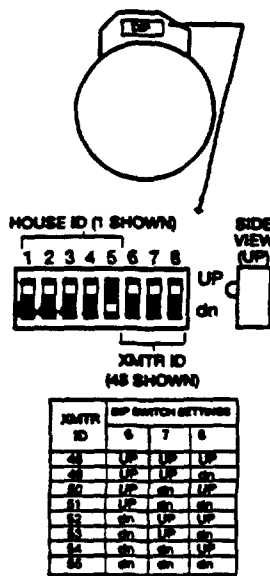

5775 PIR Detector/Transmitter

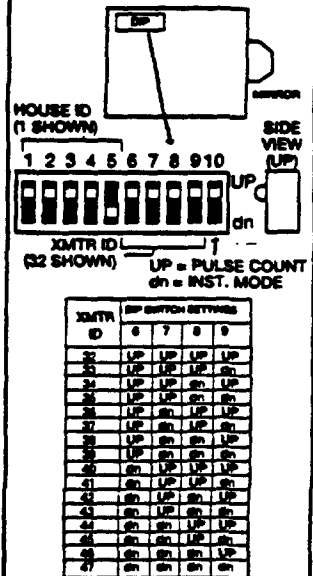

5715 Universal Xmtr.

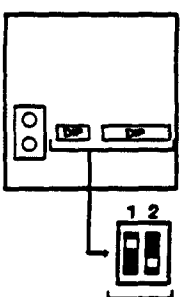

POS. 1: UP = NORMAL RESPONSE
dn = FAST RESPONSE
POS. 2: UP = NO COVER TAMPER
dn = COVER TAMPER (use N.C. setting)

XMTR ID	DIP SWITCH SETTINGS
1	UP UP UP UP UP dn
2	UP UP UP UP dn UP
3	UP UP UP dn UP UP
4	UP UP dn UP UP UP
5	UP dn UP UP UP UP
6	UP dn UP dn UP UP
7	UP dn dn UP UP UP
8	UP dn dn dn UP UP
9	UP dn dn dn dn UP
10	dn UP UP UP UP UP
11	dn UP UP UP dn UP
12	dn UP UP dn UP UP
13	dn UP UP dn dn UP
14	dn UP dn UP UP UP
15	dn UP dn UP dn UP
16	dn UP dn dn UP UP
17	dn UP dn dn dn UP
18	dn dn UP UP UP UP
19	dn dn UP UP dn UP
20	dn dn UP dn UP UP
21	dn dn dn UP UP UP
22	dn dn dn dn UP UP
23	dn dn dn dn dn UP
24	dn dn dn dn dn dn
25	dn dn dn dn dn dn
26	dn dn dn dn dn dn
27	dn dn dn dn dn dn
28	dn dn dn dn dn dn
29	dn dn dn dn dn dn
30	dn dn dn dn dn dn
31	dn dn dn dn dn dn
32	dn dn dn dn dn dn

SET VALUE: 28 16 8 4 2 1

5711/5711WM Door/Window Transmitter

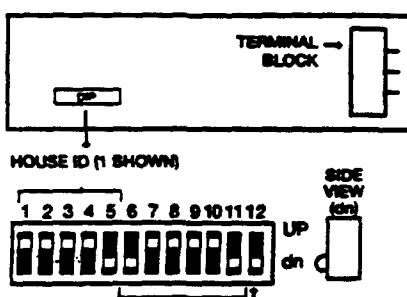

XMTR ID	DIP SWITCH SETTINGS
32	dn UP UP UP UP UP
33	dn UP UP UP UP dn
34	dn UP UP dn UP UP
35	dn UP dn UP UP UP
36	dn dn UP UP UP UP
37	dn dn UP dn UP UP
38	dn dn dn UP UP UP
39	dn dn dn dn UP UP
40	dn dn dn dn dn UP
41	dn dn dn dn dn dn
42	dn dn dn dn dn dn
43	dn dn dn dn dn dn
44	dn dn dn dn dn dn
45	dn dn dn dn dn dn
46	dn dn dn dn dn dn
47	dn dn dn dn dn dn
48	dn dn dn dn dn dn
49	dn dn dn dn dn dn
50	dn dn dn dn dn dn
51	dn dn dn dn dn dn
52	dn dn dn dn dn dn
53	dn dn dn dn dn dn
54	dn dn dn dn dn dn
55	dn dn dn dn dn dn
56	dn dn dn dn dn dn
57	dn dn dn dn dn dn
58	dn dn dn dn dn dn
59	dn dn dn dn dn dn
60	dn dn dn dn dn dn
61	dn dn dn dn dn dn
62	dn dn dn dn dn dn
63	dn dn dn dn dn dn

SET VALUE: 28 16 8 4 2 1

IMPORTANT SET SWITCHES WITH BATTERY REMOVED

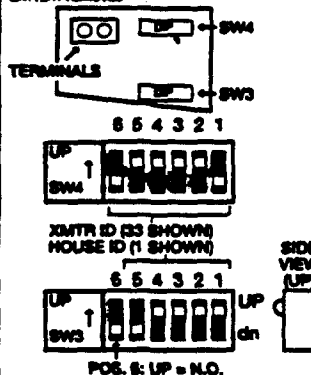

HOUSE ID	DIP SWITCH SETTINGS
1	dn UP UP UP UP
2	dn UP UP UP dn
3	dn UP UP dn UP
4	dn UP dn UP UP
5	dn dn UP UP UP
6	dn dn UP dn UP
7	dn dn dn UP UP
8	dn dn dn dn UP
9	dn dn dn dn dn
10	dn dn dn dn dn
11	dn dn dn dn dn
12	dn dn dn dn dn
13	dn dn dn dn dn
14	dn dn dn dn dn
15	dn dn dn dn dn
16	dn dn dn dn dn
17	dn dn dn dn dn
18	dn dn dn dn dn
19	dn dn dn dn dn
20	dn dn dn dn dn
21	dn dn dn dn dn
22	dn dn dn dn dn
23	dn dn dn dn dn
24	dn dn dn dn dn
25	dn dn dn dn dn
26	dn dn dn dn dn
27	dn dn dn dn dn
28	dn dn dn dn dn
29	dn dn dn dn dn
30	dn dn dn dn dn
31	dn dn dn dn dn

SET VALUE: 1 2 4 8 16

5716 Door/Window Transmitter

TRANSMITTER ID	DIP SWITCH SETTINGS
1	dn UP UP UP UP
2	dn UP UP UP dn
3	dn UP UP dn UP
4	dn UP dn UP UP
5	dn dn UP UP UP
6	dn dn UP dn UP
7	dn dn dn UP UP
8	dn dn dn dn UP
9	dn dn dn dn dn
10	dn dn dn dn dn
11	dn dn dn dn dn
12	dn dn dn dn dn
13	dn dn dn dn dn
14	dn dn dn dn dn
15	dn dn dn dn dn
16	dn dn dn dn dn
17	dn dn dn dn dn
18	dn dn dn dn dn
19	dn dn dn dn dn
20	dn dn dn dn dn
21	dn dn dn dn dn
22	dn dn dn dn dn
23	dn dn dn dn dn
24	dn dn dn dn dn
25	dn dn dn dn dn
26	dn dn dn dn dn
27	dn dn dn dn dn
28	dn dn dn dn dn
29	dn dn dn dn dn
30	dn dn dn dn dn
31	dn dn dn dn dn
32	dn dn dn dn dn
33	dn dn dn dn dn
34	dn dn dn dn dn
35	dn dn dn dn dn
36	dn dn dn dn dn
37	dn dn dn dn dn
38	dn dn dn dn dn
39	dn dn dn dn dn
40	dn dn dn dn dn
41	dn dn dn dn dn
42	dn dn dn dn dn
43	dn dn dn dn dn
44	dn dn dn dn dn
45	dn dn dn dn dn
46	dn dn dn dn dn
47	dn dn dn dn dn
48	dn dn dn dn dn
49	dn dn dn dn dn
50	dn dn dn dn dn
51	dn dn dn dn dn
52	dn dn dn dn dn
53	dn dn dn dn dn
54	dn dn dn dn dn
55	dn dn dn dn dn
56	dn dn dn dn dn
57	dn dn dn dn dn
58	dn dn dn dn dn
59	dn dn dn dn dn
60	dn dn dn dn dn
61	dn dn dn dn dn
62	dn dn dn dn dn
63	dn dn dn dn dn

SET VALUE: 1 2 4 8 16 32

4140XMP PROGRAMMING FORM

Refer to the installation instruction's INDEX OF PROGRAMMING FIELDS for numerical list of program fields.
 Standard default values are shown in brackets [], otherwise default = 0.
 Fields shown in italics can be programmed using the #93 Menu mode.
 Parentheses () around a field number indicate differences from 4140xmp programming fields.

SECURITY ACCESS OPTIONS

*00 INSTALLER CODE (*15) KEYSWITCH ASSIGNMENT
Enter 4 digits, 0-9 [4140] Enter partition in which keyswitch used, 1-8; [0=disable]

ASSIGN RESPONSE TYPE FOR ZONES (Enter 00-10; see Response Types box below)

*02	*03	*04	*05	1*01	1*02	1*03	1*04	1*05	1*09	
1 <input type="text"/>	9 <input type="text"/>	17 <input type="text"/>	25 <input type="text"/>	28 <input type="text"/>	33 <input type="text"/>	41 <input type="text"/>	49 <input type="text"/>	57 <input type="text"/>	88 <input type="text"/>	2nd RCVR
2 <input type="text"/>	10 <input type="text"/>	18 <input type="text"/>	26 <input type="text"/>	29 <input type="text"/>	34 <input type="text"/>	42 <input type="text"/>	50 <input type="text"/>	58 <input type="text"/>	89 <input type="text"/>	2nd RCVR
3 <input type="text"/>	11 <input type="text"/>	19 <input type="text"/>	27 <input type="text"/>	30 <input type="text"/>	35 <input type="text"/>	43 <input type="text"/>	51 <input type="text"/>	59 <input type="text"/>	90 <input type="text"/>	1st RCVR
4 <input type="text"/>	12 <input type="text"/>	20 <input type="text"/>	0/0	31 <input type="text"/>	36 <input type="text"/>	44 <input type="text"/>	52 <input type="text"/>	60 <input type="text"/>	91 <input type="text"/>	1st RCVR
5 <input type="text"/>	13 <input type="text"/>	21 <input type="text"/>	97 <input type="text"/>	32 <input type="text"/>	37 <input type="text"/>	45 <input type="text"/>	53 <input type="text"/>	61 <input type="text"/>	Use of 1 or 2 RF RCVRs requires enabling their respective faults (88-91) as troubles (type 5). Enter 00 if no annunciation is desired.	
6 <input type="text"/>	14 <input type="text"/>	22 <input type="text"/>	95 <input type="text"/> (1+0)	38 <input type="text"/>	46 <input type="text"/>	54 <input type="text"/>	62 <input type="text"/>			
7 <input type="text"/>	15 <input type="text"/>	23 <input type="text"/>	96 <input type="text"/> (3+0)	39 <input type="text"/>	47 <input type="text"/>	55 <input type="text"/>	63 <input type="text"/>			
8 <input type="text"/>	16 <input type="text"/>	24 <input type="text"/>	99 <input type="text"/> (2+0)	40 <input type="text"/>	48 <input type="text"/>	56 <input type="text"/>	64 <input type="text"/>			

NOTES: 97 = Poll Loop Short; 88 & 90 = RCVR not receiving transmitter signals. 89 & 91 = RCVR not responding, bad conn. to panel.

RESPONSE TYPES: 00 = Disabled zone; 01 = Entry/Exit #1; 02 = Entry/Exit #2; 03 = Perimeter; 04 = Interior Follower; 05 = Day/Night; 06 = 24 hour Silent Alarm; 07 = 24 hour Audible Alarm; 08 = 24 hour Auxiliary; 09 = Fire; 10 = Interior, Delay;

DESIGNATE RIGHT LOOP FOR MULTIPLEX EXPANSION 1=yes; [0=no]

*06 <input type="checkbox"/>	<input type="checkbox"/>	<input type="checkbox"/>	<input type="checkbox"/>	<input type="checkbox"/>	<input type="checkbox"/>	<input type="checkbox"/>	1*10 <input type="checkbox"/>	<input type="checkbox"/>	<input type="checkbox"/>	<input type="checkbox"/>	<input type="checkbox"/>	<input type="checkbox"/>	<input type="checkbox"/>	<input type="checkbox"/>	<input type="checkbox"/>
ZONES: 10	11	12	13	14	15	16	ZONES: 33	34	35	36	37	38	39	40	
*07 <input type="checkbox"/>	<input type="checkbox"/>	<input type="checkbox"/>	<input type="checkbox"/>	<input type="checkbox"/>	<input type="checkbox"/>	<input type="checkbox"/>	1*11 <input type="checkbox"/>	<input type="checkbox"/>	<input type="checkbox"/>	<input type="checkbox"/>	<input type="checkbox"/>	<input type="checkbox"/>	<input type="checkbox"/>	<input type="checkbox"/>	<input type="checkbox"/>
ZONES: 17	18	19	20	21	22	23	ZONES: 41	42	43	44	45	46	47	48	
*08 <input type="checkbox"/>	<input type="checkbox"/>	<input type="checkbox"/>	<input type="checkbox"/>	<input type="checkbox"/>	<input type="checkbox"/>	<input type="checkbox"/>	1*12 <input type="checkbox"/>	<input type="checkbox"/>	<input type="checkbox"/>	<input type="checkbox"/>	<input type="checkbox"/>	<input type="checkbox"/>	<input type="checkbox"/>	<input type="checkbox"/>	<input type="checkbox"/>
ZONES: 25	26	27	28	29	30	31	ZONES: 49	50	51	52	53	54	55	56	
*24 4190WH TAMPER DISABLE <input type="checkbox"/>	1-disable; [0-enable]							1*13 <input type="checkbox"/>	<input type="checkbox"/>	<input type="checkbox"/>	<input type="checkbox"/>	<input type="checkbox"/>	<input type="checkbox"/>	<input type="checkbox"/>	<input type="checkbox"/>
*86 ZONE EXPANDER DEVICE <input type="checkbox"/>	1-only one 4208 installed for zones 10-17; [0-more than one 4208 or other devices]							ZONES: 57	58	59	60	61	62	63	64

SELECTION OF WIRELESS FOR ZONES 1-63

Enter "1" to enable a zone as wireless; 0=non-wireless

1*18 <input type="checkbox"/>	<input type="checkbox"/>	<input type="checkbox"/>	<input type="checkbox"/>	<input type="checkbox"/>	<input type="checkbox"/>	<input type="checkbox"/>	<input type="checkbox"/>
ZONES: 1	2	3	4	5	6	7	8
1*19 <input type="checkbox"/>	<input type="checkbox"/>	<input type="checkbox"/>	<input type="checkbox"/>	<input type="checkbox"/>	<input type="checkbox"/>	<input type="checkbox"/>	<input type="checkbox"/>
ZONES: 9	10	11	12	13	14	15	16
1*20 <input type="checkbox"/>	<input type="checkbox"/>	<input type="checkbox"/>	<input type="checkbox"/>	<input type="checkbox"/>	<input type="checkbox"/>	<input type="checkbox"/>	<input type="checkbox"/>
ZONES: 17	18	19	20	21	22	23	24
1*21 <input type="checkbox"/>	<input type="checkbox"/>	<input type="checkbox"/>	<input type="checkbox"/>	<input type="checkbox"/>	<input type="checkbox"/>	<input type="checkbox"/>	<input type="checkbox"/>
ZONES: 25	26	27	28	29	30	31	32
1*22 <input type="checkbox"/>	<input type="checkbox"/>	<input type="checkbox"/>	<input type="checkbox"/>	<input type="checkbox"/>	<input type="checkbox"/>	<input type="checkbox"/>	<input type="checkbox"/>
ZONES: 33	34	35	36	37	38	39	40
1*23 <input type="checkbox"/>	<input type="checkbox"/>	<input type="checkbox"/>	<input type="checkbox"/>	<input type="checkbox"/>	<input type="checkbox"/>	<input type="checkbox"/>	<input type="checkbox"/>
ZONES: 41	42	43	44	45	46	47	48
1*24 <input type="checkbox"/>	<input type="checkbox"/>	<input type="checkbox"/>	<input type="checkbox"/>	<input type="checkbox"/>	<input type="checkbox"/>	<input type="checkbox"/>	<input type="checkbox"/>
ZONES: 49	50	51	52	53	54	55	56
1*25 <input type="checkbox"/>	<input type="checkbox"/>	<input type="checkbox"/>	<input type="checkbox"/>	<input type="checkbox"/>	<input type="checkbox"/>	<input type="checkbox"/>	<input type="checkbox"/>
ZONES: 57	58	59	60	61	62	63	

MISCELLANEOUS WIRELESS OPTIONS

1*26 FIRST RF RECEIVER SELECT 1=yes; [0=no]

1*27 SECOND RF RECEIVER SELECT 1=yes; [0=no]

1*28 RF TRANSMITTER LOW 1=immediate; [0=when disarmed]
 BATTERY ANNUN. Must be "1" for UL

1*29 RF TRANSMITTER LOW 1=enable; [0=disable]
 BATTERY REPORT ENABLE Must be "1" for UL

1*30 RF RECEIVER SUPERVISION
 CHECK-IN INTERVAL 02-15 times 2 hours;
 00 disables supervision [6] Max. "6" (12 hr) for UL

1*31 RF TRANSMITTER
 CHECK-IN INTERVAL 02-15 times 2 hours;
 00 disables transmitter supervision [12] Max. "6" (12 hr) for UL

1*44 WIRELESS KEYPAD
 TAMPER DETECT ENABLE 1=enable; [0=disable]

(1*48) WIRELESS KEYPAD ASSIGNMENT
 0=disable; enter partition in which RF keypad used, 1-8.

1*49 DISABLE TROUBLE SOUNDER
 FOR RF SUPERVISION [1=disable; 0=enable. Must be "0" for UL.

AC LOSS OPTIONS

*17 AC POWER LOSS SOUNDING 1=yes; [0=no]

*18 AC POWER LOSS ALARM 1=yes; [0=no]

*19 AC RANDOMIZE 1=randomize 10-40 min.; [0=no]

*28 POWER UP IN PREVIOUS STATE
 [1=yes; 0=no; "1" for UL.

283

ALARM REPORT CODE & ID DIGITS FOR ZONES 1-32 & SUPV. & RESTORE CODES (All codes default to 00)

*54 CODE	*55 ID	*56 CODE	*57 ID	*58	*59 CODE	*60 ID	*61 CODE	*62 ID	*63
1		9		Alarm Rst.	17		25		Alarm Rst.
2		10		Trouble	18		26		Trouble
3		11		Trble Rst.	19		27		Trble Rst.
4		12		Bypass	20		28		Bypass
5		13		Bypas Rst.	21		29		Bypas Rst.
6		14			22		30		
7		15			23		31		
8		16			24		32		

ALARM REPORT CODE & ID DIGITS FOR ZONES 33-64 & SUPERV. & RESTORE CODES (All codes default to 00)

*64 CODE	*65 ID	*66 CODE	*67 ID	*68	*69 CODE	*70 ID	*71 CODE	*72 ID	*73
33		41		Alarm Rst.	49		57		Alarm Rst.
34		42		Trouble	50		58		Trouble
35		43		Trble Rst.	51		59		Trble Rst.
36		44		Bypass	52		60		Bypass
37		45		Bypas Rst.	53		61		Bypas Rst.
38		46			54		62		
39		47			55		63		
40		48			56		64		

ALARM REPORT CODE & ID DIGITS FOR RF RCVR & PANICS, & THEIR SUPV. & RESTORE CODES

(All codes default to 00)

*74 CODE	*75 ID	*78
88		Alarm Rst.
*76 CODE	*77 ID	Trouble
89		Trble Rst.
90		Bypass
91		Bypas Rst.
		Duress
97		Poll loop short
95		(1 + #)
96		(3 + #)
99		(# + #)

NOTES: 97 = Poll Loop Short; 88 & 90 = RCVR not receiving transmitter signals. 89 & 91 = RCVR not responding, bad conn. to panel.

SYSTEM NON ALARM CODES

	*81	*82	
	First Digit	Second Digit	
Close			Second digit of each code applies only to 4+2 or expanded (fields *52 & *53) formats.
Open			
Low Battery			
Low Bat Res			
AC Loss			
AC Restore			
Test			
Power			
Cancel			
Prog. Temp.			

ZONE TYPE RESTORE ENABLES 1=enable; [0=disable]

*79	ZONE TYPES 1-8	*80	TYPES 9&10
	1 2 3 4 5 6 7 8		9 10

OPEN/CLOSE REPORTING FOR KEYSWITCH

(*40) 1=enable; [0=disable]

EVENT LOGGING FIELDS

(Real time clock must be set-code + [#] + 63)

(1*70) EVENT LOG TYPES

1=enable logging; 0=disable Alarm Chk Byp OC Syst

(1*71) 12/24 HOUR TIME STAMP FORMAT

[0=12 hour]; 1=24 hour

(1*72) EVENT LOG PRINTER ON-LINE

[0=disable]; 1=enable

(1*73) PRINTER BAUD RATE 1=300; [0=1200]

EVENT LOGGING DIALER CODES

	1*40	1*41
	First Digit	Second Digit
Armed STAY		
Time/Date set or event log reset		
Event log 50% & 90% full		
Event log overflow		

285

PARTITION-SPECIFIC PROGRAM FIELDS

(Duplicate this page for the partitions used in the installation.)

To program these fields, enter a partition-specific field number.

To select the next partition, press *91.

To return to the global program fields, press *99.

PARTITION #	PROGRAM FIELDS
*09	ENTRY DELAY #1 <input type="text"/> <input type="text"/> [02] (00-15 times 15 seconds)
*10	EXIT DELAY #1 <input type="text"/> <input type="text"/> [03] (00-15 times 15 seconds)
*11	ENTRY DELAY #2 <input type="text"/> <input type="text"/> [06] (00-15 times 15 seconds)
*12	EXIT DELAY #2 <input type="text"/> <input type="text"/> [08] (00-15 times 15 seconds)
*13	ALARM SOUNDER DURATION <input type="text"/> <input type="text"/> 01-15 times 2 minutes [04]. Minimum 4 minutes for UL.
*16	CONFIRMATION OF ARMING DING <input type="checkbox"/> 1=enable; [0=disable]
*22	CONSOLE PANIC ENABLES <input type="checkbox"/> <input type="checkbox"/> <input type="checkbox"/> 1=enable; 0=disable [0-0-1] 95 96 99
*23	MULTIPLE ALARMS <input type="checkbox"/> [1=yes; 0=no]
*29	QUICK ARM <input type="checkbox"/> [1=yes; 0=no]
*32	PRIMARY SUBSCRIBER ACCT # <input type="text"/> <input type="text"/> <input type="text"/> <input type="text"/> Enter 00-09; B-F (11-15) [15 15 15 15]
*38	INHIBIT BYPASS OF A ZONE <input type="text"/> <input type="text"/> 01-31; [00 if all zones (except Fire zones) can be bypassed]
*39	ENABLE OPEN/CLOSE REPORT <input type="checkbox"/> FOR INSTALLER CODE 1=enable; [0=disable]
*84	SWINGER SUPPRESSION <input type="text"/> <input type="text"/> 01-15 alarms [15]; Must be "00" (disabled) for UL.
*85	ENABLE DIALER REPORTS <input type="checkbox"/> <input type="checkbox"/> <input type="checkbox"/> <input type="checkbox"/> FOR PANICS & DURESS 95 96 99 Duress 1=enable; [0=disable]
*87	ENTRY WARNING <input type="checkbox"/> [1=continuous; 0=3 beeps]
*88	BURG. ALARM COMM. DELAY <input type="text"/> <input type="text"/> 1=16 seconds; [0=no delay]
*90	SECONDARY SUBSCRIBER ACCT # <input type="text"/> <input type="text"/> <input type="text"/> <input type="text"/> Enter 00-09; B-F (11-15) [15 15 15 15]
1*43	ENABLE PERM. BACKLIGHT <input type="checkbox"/> 1=enable; [0=disable]
1*45	ENABLE CONSOLE <input type="checkbox"/> 1=enable; [0=disable] ANNUN. DURING EXIT DELAY
1*47	ENABLE CHIME ANNUN. <input type="checkbox"/> 1=enable; [0=disable] ON EXTERNAL ALARM SOUNDER
1*52	CANCEL REPORT RESTRICTION <input type="checkbox"/> 1=no restriction; [0=within Bell Timeout period only]
2*18	ENABLE GOTO FOR THIS PARTITION <input type="checkbox"/> 1=enable; [0=disable]

PARTITION #	PROGRAM FIELDS
*09	ENTRY DELAY #1 <input type="text"/> <input type="text"/> [02] (00-15 times 15 seconds)
*10	EXIT DELAY #1 <input type="text"/> <input type="text"/> [03] (00-15 times 15 seconds)
*11	ENTRY DELAY #2 <input type="text"/> <input type="text"/> [06] (00-15 times 15 seconds)
*12	EXIT DELAY #2 <input type="text"/> <input type="text"/> [08] (00-15 times 15 seconds)
*13	ALARM SOUNDER DURATION <input type="text"/> <input type="text"/> 01-15 times 2 minutes [04]. Minimum 4 minutes for UL.
*16	CONFIRMATION OF ARMING DING <input type="checkbox"/> 1=enable; [0=disable]
*22	CONSOLE PANIC ENABLES <input type="checkbox"/> <input type="checkbox"/> <input type="checkbox"/> 1=enable; 0=disable [0-0-1] 95 96 99
*23	MULTIPLE ALARMS <input type="checkbox"/> [1=yes; 0=no]
*29	QUICK ARM <input type="checkbox"/> [1=yes; 0=no]
*32	PRIMARY SUBSCRIBER ACCT # <input type="text"/> <input type="text"/> <input type="text"/> <input type="text"/> Enter 00-09; B-F (11-15) [15 15 15 15]
*38	INHIBIT BYPASS OF A ZONE <input type="text"/> <input type="text"/> 01-31; [00 if all zones (except Fire zones) can be bypassed]
*39	ENABLE OPEN/CLOSE REPORT <input type="checkbox"/> FOR INSTALLER CODE 1=enable; [0=disable]
*84	SWINGER SUPPRESSION <input type="text"/> <input type="text"/> 01-15 alarms [15]; Must be "00" (disabled) for UL.
*85	ENABLE DIALER REPORTS <input type="checkbox"/> <input type="checkbox"/> <input type="checkbox"/> <input type="checkbox"/> FOR PANICS & DURESS 95 96 99 Duress 1=enable; [0=disable]
*87	ENTRY WARNING <input type="checkbox"/> [1=continuous; 0=3 beeps]
*88	BURG. ALARM COMM. DELAY <input type="text"/> <input type="text"/> 1=16 seconds; [0=no delay]
*90	SECONDARY SUBSCRIBER ACCT # <input type="text"/> <input type="text"/> <input type="text"/> <input type="text"/> Enter 00-09; B-F (11-15) [15 15 15 15]
1*43	ENABLE PERM. BACKLIGHT <input type="checkbox"/> 1=enable; [0=disable]
1*45	ENABLE CONSOLE <input type="checkbox"/> 1=enable; [0=disable] ANNUN. DURING EXIT DELAY
1*47	ENABLE CHIME ANNUN. <input type="checkbox"/> 1=enable; [0=disable] ON EXTERNAL ALARM SOUNDER
1*52	CANCEL REPORT RESTRICTION <input type="checkbox"/> 1=no restriction; [0=within Bell Timeout period only]
2*18	ENABLE GOTO FOR THIS PARTITION <input type="checkbox"/> 1=enable; [0=disable]

INDEX TO PROGRAM FIELDS

FLD	FUNCTION	SECTION
*00	INSTALLER CODE	ACCESS OPTS
*02	RESPONSE TYPE FOR ZONES 1-8	RESPONSE TYPES
*03	RESPONSE TYPE FOR ZONES 9-16	RESPONSE TYPES
*04	RESPONSE TYPE FOR ZONES 17-24	RESPONSE TYPES
*05	RESPONSE TYPE FOR ZONES 25-27	RESPONSE TYPES
*06	RIGHT LOOP FOR ZONES: 10-16	RIGHT LOOP
*07	RIGHT LOOP FOR ZONES: 17-24	RIGHT LOOP
*08	RIGHT LOOP FOR ZONES: 25-32	RIGHT LOOP
*09	ENTRY DELAY #1	PARTITIONED FIELD
*10	EXIT DELAY #1	PARTITIONED FIELD
*11	ENTRY DELAY #2	PARTITIONED FIELD
*12	EXIT DELAY #2	PARTITIONED FIELD
*13	ALARM SOUNDER DURATION	PARTITIONED FIELD
*14	ZONE 9 FAST/SLOW RESPONSE	MISC SYSTEM OPTS
*15	KEYSWITCH ASSIGNMENT	ACCESS OPTS
*16	CONFIRMATION OF ARMING DING	PARTITIONED FIELD
*17	AC POWER LOSS SOUNDING	AC LOSS OPTS
*18	AC POWER LOSS ALARM	AC LOSS OPTS
*19	AC RANDOMIZE	AC LOSS OPTS
*21	DISABLE FIRE TIME-OUT	MISC SYSTEM OPTS
*22	CONSOLE PANIC ENABLES	PARTITIONED FIELD
*23	MULTIPLE ALARMS	PARTITIONED FIELD
*24	4190WH TAMPER DISABLE	RIGHT LOOP
*25	RESP. TYPE 8 BURGLARY TRIGGER	MISC SYSTEM OPTS
*26	INTELLIGENT TEST REPORTING	TEST TIMER
*27	TEST REPORT INTERVAL	TEST TIMER
*28	POWER UP IN PREVIOUS STATE	AC LOSS OPTS
*29	QUICK ARM	PARTITIONED FIELD
*30	TOUCH-TONE OR ROTARY DIAL	PHONE LINE/COMM.
*31	PABX ACCESS CODE	PHONE LINE/COMM.
*32	PRIMARY SUBSCRIBER ACCT #	PARTITIONED FIELD
*33	PRIMARY PHONE NUMBER	PHONE LINE/COMM.
*34	SECONDARY PHONE NUMBER	PHONE LINE/COMM.
*35	DOWNLOAD PHONE No.	DOWNLOADING
*36	DOWNLOAD ID No.	DOWNLOADING
*37	DOWNLOAD COMMAND ENABLES	DOWNLOADING
*38	INHIBIT BYPASS OF ONE ZONE	PARTITIONED FIELD
*39	OPEN/CLOSE REPORTING ENABLE FOR INSTALLER CODE	PARTITIONED FIELD
*40	OPEN/CLOSE REPORTING ENABLE FOR KEYSWITCH	OPEN/CLOSE REP.
*41	EOLR DISABLE (Zones 2-8)	MISC SYSTEM OPTS
*42	DIAL TONE PAUSE	PHONE LINE/COMM.
*43	DIAL TONE DETECTION	PHONE LINE/COMM.
*44	RING DETECTION COUNT	DOWNLOADING
*45	PRIMARY FORMAT	PHONE LINE/COMM.
*46	LOW SPEED FORMAT	PHONE LINE/COMM.
*47	SECONDARY FORMAT	PHONE LINE/COMM.
*48	LOW SPEED FORMAT (Sec.)	PHONE LINE/COMM.
*49	CHECKSUM VERIFICATION	PHONE LINE/COMM.
*50	SESCO/RADIONICS SELECT	PHONE LINE/COMM.
*51	DUAL REPORTING	PHONE LINE/COMM.
*52	STANDARD/EXP REPORT PRIMARY	PHONE LINE/COMM.
*53	STANDARD/EXP REPORT SECNDRY	PHONE LINE/COMM.
*54-78	REPORT CODES FOR ZONES 1-64	ALARM CODES
*79-80	ZONE TYPE RESTORE ENABLES	ZONE TYPE REST.
*81-82	SYSTEM NON-ALARM CODES	SYSTEM CODES
*83	FIRST TEST REPORT TIME	TEST TIMER

FLD	FUNCTION	SECTION
*84	SWINGER SUPPRESSION	PARTITIONED FIELD
*85	PANIC & DURESS DIALER ENABLE	PARTITIONED FIELD
*86	ZONE EXPANDER DEVICE	RIGHT LOOP
*87	ENTRY WARNING	PARTITIONED FIELD
*88	BURG. ALARM COMM. DELAY	PARTITIONED FIELD
*89	RESTOR REPORT TIMING	TEST TIMER
*90	SECONDARY SUBSCRIBER ACCT	PARTITIONED FIELD
1*01	RESPONSE TYPE FOR ZONES 28-32	RESPONSE TYPES
1*02	RESPONSE TYPE FOR ZONES 33-40	RESPONSE TYPES
1*03	RESPONSE TYPE FOR ZONES 41-48	RESPONSE TYPES
1*04	RESPONSE TYPE FOR ZONES 49-56	RESPONSE TYPES
1*05	RESPONSE TYPE FOR ZONES 57-64	RESPONSE TYPES
1*08	RESPONSE TYPE FOR ZONE 88	RESPONSE TYPES
1*09	RESPONSE TYPE FOR ZONES 89-91	RESPONSE TYPES
1*10	RIGHT LOOP FOR ZONES:33-40	RIGHT LOOP
1*11	RIGHT LOOP FOR ZONES:41-48	RIGHT LOOP
1*12	RIGHT LOOP FOR ZONES:49-56	RIGHT LOOP
1*13	RIGHT LOOP FOR ZONES:57-64	RIGHT LOOP
1*18	SELECT WIRELESS FOR ZONES 1-8	SELECT WIRELESS
1*19	SELECT WIRELESS FOR ZONES 9-16	SELECT WIRELESS
1*20	SELECT WIRELESS ZONES 17-24	SELECT WIRELESS
1*21	SELECT WIRELESS ZONES 25-32	SELECT WIRELESS
1*22	SELECT WIRELESS ZONES 33-40	SELECT WIRELESS
1*23	SELECT WIRELESS ZONES 41-48	SELECT WIRELESS
1*24	SELECT WIRELESS ZONES 49-56	SELECT WIRELESS
1*25	SELECT WIRELESS ZONES 57-63	SELECT WIRELESS
1*26	1st RF RECEIVER EXP SELECT	MISC WIRELESS
1*27	2nd RF RECEIVER EXP SELECT	MISC WIRELESS
1*28	RF TRANSMITTER LOW	MISC WIRELESS
1*29	RF TRANS. LOW BATTERY ANNUN	MISC WIRELESS
1*30	RF RECEIVER SUPERVISION	MISC WIRELESS
1*31	RF TRANS.CHECK-IN INTERVAL	MISC WIRELESS
1*33	TOUCHTONE DIAL W/ROTARY BACK-UP ENABLE	PHONE LINE/COMM.
1*34	COMMUNICATOR SPLIT REPORTING	PHONE LINE/COMM.
1*40-1*41	EVENT LOG DIALER CODES	EVENT LOGGING
1*43	ENABLE PERM. BACKLIGHTING	PARTITIONED FIELD
1*44	WIRELESS KEYPAD	MISC WIRELESS
1*45	ENABLE CONSOLE ANNUN. DURING EXIT DELAY	PARTITIONED FIELD
1*46	AUXILIARY OUTPUT ENABLE	MISC SYSTEM OPTS
1*47	ENABLE CHIME ANNUN. ON EXTERNAL ALARM SOUNDER	PARTITIONED FIELD
1*48	WIRELESS KEYPAD ASSIGNMENT	MISC WIRELESS
1*49	DISABLE TROUBLE SOUNDER FOR RF SUPERVISION	MISC WIRELESS
1*50	BABYSITTER CODE ENABLE	ACCESS OPTS
1*52	CANCEL REPORT RESTRICTION	PARTITIONED FIELD
1*53	DOWNLOAD CALLBACK	DOWNLOADING
1*54	SECURITY CODE MODE	ACCESS OPTS
1*70	EVENT LOG TYPES	EVENT LOGGING
1*71	12/24 HOUR TIME STAMP FORMAT	EVENT LOGGING
1*72	EVENT LOG PRINTER ON-LINE	EVENT LOGGING
1*73	PRINTER BAUD RATE	EVENT LOGGING
2*00	NUMBER OF PARTITIONS	PARTITION SYSTEM
2*01-2*08	ASSIGN ZONES TO PARTITION	PARTITION SYSTEM
2*17	NUMBER OF CODES/PARTITION	PARTITION SYSTEM
2*18	ENABLE GOTO FOR A PARTITION	PARTITION SYSTEM
2*19	USE PARTITION DESCRIPTORS	PARTITION SYSTEM

287

COMMUNICATION DEFAULTS for LOW SPEED FORMAT (*94*80)

- *45 PRIMARY FORMAT Ademco Low Speed
- *46 LOW SPEED FORMAT (Primary) Ademco Low Speed
- *47 SECONDARY FORMAT Ademco Low Speed
- *48 LOW SPEED FORMAT (Sec.) Ademco Low Speed
- *49 CHECKSUM VERIFICATION
No checksum Primary Secondary
- *50 SESCOA/RADIONICS SELECT Radionics
- *51 DUAL REPORTING no
- *52 STANDARD/EXPANDED REPORT FOR PRIMARY
 standard
Alarm Rstr Bypass Trbl Opr/Cls Low Bat
- *53 STANDARD/EXPANDED REPORT FOR SECONDARY
 standard
Alarm Rstr Bypass Trbl Opr/Cls Low Bat

ALARM REPORT CODE & ID DIGITS FOR ZONES 1-32 & SUPERVISORY & RESTORE CODES

*54 CODE	*55 ID	*56 CODE	*57 ID	*58	*59 CODE	*60 ID	*61 CODE	*62 ID	*63					
1	01	00	03	00	09	Alarm Rst.	17	03	00	25	03	00	09	Alarm Rst.
2	03	00	10	03	00	Trouble	18	03	00	26	03	00	00	Trouble
3	03	00	11	03	00	Trble Rst.	19	03	00	27	03	00	00	Trble Rst.
4	03	00	12	03	00	Bypass	20	03	00	28	03	00	00	Bypass
5	03	00	13	03	00	Bypass Rst.	21	03	00	29	03	00	00	Bypass Rst.
6	03	00	14	03	00		22	03	00	30	03	00		
7	03	00	15	03	00		23	03	00	31	03	00		
8	03	00	16	03	00		24	03	00	32	03	00		

ALARM REPORT CODE & ID DIGITS FOR ZONES 33-64 & SUPERVISORY & RESTORE CODES

*64 CODE	*65 ID	*66 CODE	*67 ID	*68	*69 CODE	*70 ID	*71 CODE	*72 ID	*73						
33	03	00	41	03	00	09	Alarm Rst.	49	01	00	57	03	00	09	Alarm Rst.
34	03	00	42	03	00	00	Trouble	50	01	00	58	03	00	00	Trouble
35	03	00	43	03	00	00	Trble Rst.	51	01	00	59	03	00	00	Trble Rst.
36	03	00	44	03	00	00	Bypass	52	01	00	60	03	00	00	Bypass
37	03	00	45	03	00	00	Bypass Rst.	53	01	00	61	03	00	00	Bypass Rst.
38	03	00	46	03	00			54	01	00	62	02	00		
39	03	00	47	03	00			55	01	00	63	02	00		
40	03	00	48	01	00			56	03	00	64	03	00		

ALARM REPORT CODE & ID DIGITS FOR RF RCVRs & PANICS & THEIR SUPV. & RESTORE CODES

*74 CODE	*75 ID	*76 CODE	*77 ID	*78			
NU	00	00	89	07	00	09	Alarm Rst.
NU	00	00	90	07	00	00	Trouble
NU	00	00	91	07	00	00	Trble Rst.
NU	00	00	Dures	02	00	00	Bypass
NU	00	00	97	07	00	00	Bypass Rst.
NU	00	00	95	02	00	(1 + *)	
NU	00	00	96	02	00	(3 + *)	
88	07	00	99	02	00	(* + *)	

NOTES: 97= Poll Loop Short; 88 & 90 = RCVR not receiving transmitter signals. 89 & 91 = RCVR not responding, bad conn. to panel.

SYSTEM NON ALARM CODES

	*81 First Digit	*82 Second Digit	
Close	00	00	Second digit of each code applies only to 4+2 or expanded (fields *52 & *53) formats.
Open	00	00	
Low Battery	00	00	
Low Bat Res.	00	00	
AC Loss	00	00	
AC Restore	00	00	
Test	00	00	
Power	00	00	
Cancel	00	00	
Prog. Tamper	00	00	

- ZONE TYPE RESTORE ENABLES**
- *79 ZONE TYPES 1-8 All enabled

 1 2 3 4 5 6 7 8
 - *80 ZONE TYPES 9 & 10 All enabled

 9 10

COMMUNICATION DEFAULTS for ADEMCO EXPRESS FORMAT (*94*81)

- *45 PRIMARY FORMAT Ademco Express
- *46 LOW SPEED FORMAT (Primary)
- *47 SECONDARY FORMAT Ademco Express
- *48 LOW SPEED FORMAT (Sec.)
- *49 CHECKSUM VERIFICATION
No checksum Primary Secondary
- *50 SESCO/RADIONICS SELECT Radionics
- *51 DUAL REPORTING no
- *52 STANDARD/EXPANDED REPORT FOR PRIMARY
 standard
Alarm Retr Bypass Trbl Opn/Cls Low Bat
- *53 STANDARD/EXPANDED REPORT FOR SECONDARY
 standard
Alarm Retr Bypass Trbl Opn/Cls Low Bat

ALARM REPORT CODE & ID DIGITS FOR ZONES 1-32 & SUPERVISORY & RESTORE CODES

*54 CODE	*55 ID	*56 CODE	*57 ID	*58	*59 CODE	*60 ID	*61 CODE	*62 ID	*63						
1	1 0	0 1	9	1 0	0 9	1 4	Alarm Ret.	17	0 1	0 7	25	0 2	0 5	1 4	Alarm Ret.
2	1 0	0 2	10	0 1	1 0	0 0	Trouble	18	0 1	0 8	26	0 2	0 6	0 0	Trouble
3	1 0	0 3	11	0 1	0 1	0 0	Trble Ret.	19	0 1	0 9	27	0 2	0 7	0 0	Trble Ret.
4	1 0	0 4	12	0 1	0 2	0 0	Bypass	20	0 2	1 0	28	0 2	0 8	0 0	Bypass
5	1 0	0 5	13	0 1	0 3	0 0	Bypas Ret.	21	0 2	0 1	29	0 2	0 9	0 0	Bypas Ret.
6	1 0	0 6	14	0 1	0 4			22	0 2	0 2	30	0 3	1 0		
7	1 0	0 7	15	0 1	0 5			23	0 2	0 3	31	0 3	0 1		
8	1 0	0 8	16	0 1	0 6			24	0 2	0 4	32	0 3	0 2		

ALARM REPORT CODE & ID DIGITS FOR ZONES 33-64 & SUPERVISORY & RESTORE CODES

*64 CODE	*65 ID	*66 CODE	*67 ID	*68	*69 CODE	*70 ID	*71 CODE	*72 ID	*73						
33	0 3	0 3	41	0 4	0 1	1 4	Alarm Ret.	49	0 4	0 9	57	0 5	0 7	1 4	Alarm Ret.
34	0 3	0 4	42	0 4	0 2	0 0	Trouble	50	0 5	1 0	58	0 5	0 8	0 0	Trouble
35	0 3	0 5	43	0 4	0 3	0 0	Trble Ret.	51	0 5	0 1	59	0 5	0 9	0 0	Trble Ret.
36	0 3	0 6	44	0 4	0 4	0 0	Bypass	52	0 5	0 2	60	0 6	1 0	0 0	Bypass
37	0 3	0 7	45	0 4	0 5	0 0	Bypas Ret.	53	0 5	0 3	61	0 6	0 1	0 0	Bypas Ret.
38	0 3	0 8	46	0 4	0 6			54	0 5	0 4	62	0 6	0 2		
39	0 3	0 9	47	0 4	0 7			55	0 5	0 5	63	0 6	0 3		
40	0 4	1 0	48	0 4	0 8			56	0 5	0 6	64	0 6	0 4		

ALARM REPORT CODE & ID DIGITS FOR RF RCVRs & PANICS & THEIR SUPV & RESTORE CODES

*74 CODE	*75 ID	*76 CODE	*77 ID	*78			
NU	0 0	0 0	89	0 8	0 9	1 4	Alarm Ret.
NU	0 0	0 0	90	0 9	1 0	0 0	Trouble
NU	0 0	0 0	91	0 9	0 1	0 0	Trble Ret.
NU	0 0	0 0	Dura	1 3	1 3	0 0	Bypass
NU	0 0	0 0	97	0 9	0 7	0 0	Bypas Ret.
NU	0 0	0 0	95	0 9	0 5	(1 + 8)	
NU	0 0	0 0	96	0 9	0 6	(3 + 8)	
88	0 8	0 8	99	0 9	0 9	(8 + 8)	

NOTES: 97 = Poll Loop Short; 88 & 90 = RCVR not receiving transmitter signals. 89 & 91 = RCVR not responding, bad conn. to panel.

SYSTEM NON ALARM CODES

	*81 First Digit	*82 Second Digit
Close	0 0	0 0
Open	0 0	0 0
Low Battery	0 0	0 0
Low Bat Res.	0 0	0 0
AC Loss	0 0	0 0
AC Restore	0 0	0 0
Test	0 0	0 0
Power	0 0	0 0
Cancel	0 0	0 0
Prog. Tamper	0 0	0 0

Second digit of each code applies only to 4+2 or expanded (fields *52 & *53) formats.

ZONE TYPE RESTORE ENABLES

- *79 ZONE TYPES 1-8 All enabled

 1 2 3 4 5 6 7 8
- *80 ZONE TYPES 9 & 10 All enabled

 9 10

289

COMMUNICATION DEFAULTS for ADEMCO HIGH SPEED FORMAT (*94*82)

- *45 PRIMARY FORMAT 2 Ademco High Speed
- *46 LOW SPEED FORMAT (Primary) 0
- *47 SECONDARY FORMAT 2 Ademco High Speed
- *48 LOW SPEED FORMAT (Sec.) 0
- *49 CHECKSUM VERIFICATION 0 0
No checksum Primary Secondary
- *50 SESCO/RADIONICS SELECT 0 Radionics
- *51 DUAL REPORTING 0 no
- *52 STANDARD/EXPANDED REPORT FOR PRIMARY
 0 0 0 0 0 0 standard
Alarm Rstr Bypass Trbl Oprn/Cls Low Bat
- *53 STANDARD/EXPANDED REPORT FOR SECONDARY
 0 0 0 0 0 0 standard
Alarm Rstr Bypass Trbl Oprn/Cls Low Bat

ALARM REPORT CODE & ID DIGITS FOR ZONES 1-32 & SUPERVISORY & RESTORE CODES

*54 CODE	*55 ID	*56 CODE	*57 ID	*58	*59 CODE	*60 ID	*61 CODE	*62 ID	*63						
1	0 1	0 0	9	0 3	0 0	0 1	Alarm Rstr.	17	0 4	0 0	25	0 4	0 0	0 1	Alarm Rstr.
2	0 2	0 0	10	0 3	0 0	0 0	Trouble	18	0 4	0 0	26	0 4	0 0	0 0	Trouble
3	0 2	0 0	11	0 3	0 0	0 0	Trble Rstr.	19	0 4	0 0	27	0 4	0 0	0 0	Trble Rstr.
4	0 2	0 0	12	0 3	0 0	0 0	Bypass	20	0 4	0 0	28	0 4	0 0	0 0	Bypass
5	0 2	0 0	13	0 3	0 0	0 0	Bypas Rstr.	21	0 4	0 0	29	0 4	0 0	0 0	Bypas Rstr.
6	0 2	0 0	14	0 3	0 0			22	0 4	0 0	30	0 4	0 0		
7	0 2	0 0	15	0 3	0 0			23	0 4	0 0	31	0 4	0 0		
8	0 2	0 0	16	0 3	0 0			24	0 4	0 0	32	0 5	0 0		

ALARM REPORT CODE & ID DIGITS FOR ZONES 33-64 & SUPERVISORY & RESTORE CODES

*64 CODE	*65 ID	*66 CODE	*67 ID	*68	*69 CODE	*70 ID	*71 CODE	*72 ID	*73						
33	0 5	0 0	41	0 5	0 0	0 1	Alarm Rstr.	49	0 1	0 0	57	0 6	0 0	0 1	Alarm Rstr.
34	0 5	0 0	42	0 5	0 0	0 0	Trouble	50	0 1	0 0	58	0 6	0 0	0 0	Trouble
35	0 5	0 0	43	0 5	0 0	0 0	Trble Rstr.	51	0 1	0 0	59	0 6	0 0	0 0	Trble Rstr.
36	0 5	0 0	44	0 5	0 0	0 0	Bypass	52	0 1	0 0	60	0 6	0 0	0 0	Bypass
37	0 5	0 0	45	0 5	0 0	0 0	Bypas Rstr.	53	0 1	0 0	61	0 6	0 0	0 0	Bypas Rstr.
38	0 5	0 0	46	0 5	0 0			54	0 1	0 0	62	0 9	0 0		
39	0 5	0 0	47	0 5	0 0			55	0 1	0 0	63	0 9	0 0		
40	0 5	0 0	48	0 1	0 0			56	0 6	0 0	64	0 6	0 0		

ALARM REPORT CODE & ID DIGITS FOR RF RCVRs & PANICS & THEIR SUPV & RESTORE CODES

*74 CODE	*75 ID	*76 CODE	*77 ID	*78			
NU	0 0	0 0	89	0 7	0 0	0 1	Alarm Rstr.
NU	0 0	0 0	90	0 8	0 0	0 0	Trouble
NU	0 0	0 0	91	0 8	0 0	0 0	Trble Rstr.
NU	0 0	0 0	Dures	0 1	0 0	0 0	Bypass
NU	0 0	0 0	97	0 7	0 0	0 0	Bypas Rstr.
NU	0 0	0 0	95	1 0	0 0	(1 + *)	
NU	0 0	0 0	96	1 1	0 0	(3 + *)	
88	0 7	0 0	99	1 2	0 0	(8 + *)	

NOTES: 97= Poll Loop Short; 88 & 90 = RCVR not receiving transmitter signals. 89 & 91 = RCVR not responding, bad conn. to panel.

SYSTEM NON ALARM CODES

	*81 First Digit	*82 Second Digit
Close	0 0	0 0
Open	0 0	0 0
Low Battery	0 0	0 0
Low Bat Res.	0 0	0 0
AC Loss	0 0	0 0
AC Restore	0 0	0 0
Test	0 0	0 0
Power	0 0	0 0
Cancel	0 0	0 0
Prog. Tamper	0 0	0 0

Second digit of each code applies only to 4-2 or expanded (fields *52 & *53) formats.

ZONE TYPE RESTORE ENABLES

- *79 ZONE TYPES 1-8 All enabled
 1 2 3 4 5 6 7 8
- *80 ZONE TYPES 9 & 10 All enabled
 9 10

COMMUNICATION DEFAULTS for ADEMCO's CONTACT ID FORMAT (*94*83)

- *45 PRIMARY FORMAT Ademco Contact ID
- *46 LOW SPEED FORMAT (Primary)
- *47 SECONDARY FORMAT Ademco Contact ID
- *48 LOW SPEED FORMAT (Sec.)
- *49 CHECKSUM VERIFICATION Primary Secondary
No checksum
- *50 SESCOA/RADIONICS SELECT Radionics
- *51 DUAL REPORTING no
- *52 STANDARD/EXPANDED REPORT FOR PRIMARY
 Alarm Rstr Bypass Trbl OprvCls Low Bat standard
- *53 STANDARD/EXPANDED REPORT FOR SECONDARY
 Alarm Rstr Bypass Trbl OprvCls Low Bat standard

ALARM REPORT CODE & ID DIGITS FOR ZONES 1-32 & SUPERVISORY & RESTORE CODES

*54 CODE	*55 ID	*56 CODE	*57 ID	*58	*59 CODE	*60 ID	*61 CODE	*62 ID	*63						
1	0 1	0 0	9	0 9	0 0	0 1	Alarm Rst.	17	0 2	0 0	25	1 0	0 0	0 1	Alarm Rst.
2	0 2	0 0	10	1 0	0 0	0 0	Trouble	18	0 3	0 0	26	1 1	0 0	0 0	Trouble
3	0 3	0 0	11	1 1	0 0	0 0	Trble Rst.	19	0 4	0 0	27	1 2	0 0	0 0	Trble Rst.
4	0 4	0 0	12	1 2	0 0	0 0	Bypass	20	0 5	0 0	28	1 3	0 0	0 0	Bypass
5	0 5	0 0	13	1 3	0 0	0 0	Bypas Rst.	21	0 6	0 0	29	1 4	0 0	0 0	Bypas Rst.
6	0 6	0 0	14	1 4	0 0			22	0 7	0 0	30	1 5	0 0		
7	0 7	0 0	15	1 5	0 0			23	0 8	0 0	31	0 1	0 0		
8	0 8	0 0	16	0 1	0 0			24	0 9	0 0	32	0 2	0 0		

ALARM REPORT CODE & ID DIGITS FOR ZONES 33-64 & SUPERVISORY & RESTORE CODES

*64 CODE	*65 ID	*66 CODE	*67 ID	*68	*69 CODE	*70 ID	*71 CODE	*72 ID	*73						
33	0 1	0 0	41	1 1	0 0	0 1	Alarm Rst.	49	0 4	0 0	57	1 2	0 0	0 1	Alarm Rst.
34	0 1	0 0	42	1 2	0 0	0 0	Trouble	50	0 5	0 0	58	1 3	0 0	0 0	Trouble
35	0 1	0 0	43	1 3	0 0	0 0	Trble Rst.	51	0 6	0 0	59	1 4	0 0	0 0	Trble Rst.
36	0 1	0 0	44	1 4	0 0	0 0	Bypass	52	0 7	0 0	60	1 5	0 0	0 0	Bypass
37	0 1	0 0	45	1 5	0 0	0 0	Bypas Rst.	53	0 8	0 0	61	0 1	0 0	0 0	Bypas Rst.
38	0 1	0 0	46	0 1	0 0			54	0 9	0 0	62	0 2	0 0		
39	0 1	0 0	47	0 2	0 0			55	1 0	0 0	63	0 3	0 0		
40	0 0	0 0	48	0 3	0 0			56	1 1	0 0	64	0 4	0 0		

ALARM REPORT CODE & ID DIGITS FOR RF RCVRs & PANICS & THEIR SUPV. & RESTORE CODES

*74 CODE	*75 ID	*76 CODE	*77 ID	*78			
NU	0 0	0 0	89	1 4	0 0	0 1	Alarm Rst.
NU	0 0	0 0	90	1 5	0 0	0 0	Trouble
NU	0 0	0 0	91	0 1	0 0	0 0	Trble Rst.
NU	0 0	0 0	Dures	0 2	0 0	0 0	Bypass
NU	0 0	0 0	97	0 3	0 0	0 0	Bypas Rst.
NU	0 0	0 0	95	0 4	0 0	(1 + 4)	
NU	0 0	0 0	96	0 5	0 0	(3 + 5)	
88	1 3	0 0	99	0 6	0 0	(6 + 9)	

NOTES: 97= Poll Loop Short; 88 & 90 = RCVR not receiving transmitter signals. 89 & 91 = RCVR not responding, bad conn. to panel.

SYSTEM NON ALARM CODES		
	*81 First Digit	*82 Second Digit
Close	0 0	0 0
Open	0 0	0 0
Low Battery	0 0	0 0
Low Bat Res.	0 0	0 0
AC Loss	0 0	0 0
AC Restore	0 0	0 0
Test	0 0	0 0
Power	0 0	0 0
Cancel	0 0	0 0
Prog. Tamper	0 0	0 0

Second digit of each code applies only to 4+2 or expanded (fields *52 & *53) formats.

ZONE TYPE RESTORE ENABLES

- *79 ZONE TYPES 1-8 All enabled
 1 2 3 4 5 6 7 8
- *80 ZONE TYPES 9 & 10 All enabled
 9 10

291

"FEDERAL COMMUNICATIONS COMMISSION (FCC) STATEMENT"

This equipment has been tested to FCC requirements and has been found acceptable for use. The FCC requires the following statement for your information:

This equipment generates and uses radio frequency energy and if not installed and used properly, that is, in strict accordance with the manufacturer's instructions, may cause interference to radio and television reception. It has been type tested and found to comply with the limits for a Class B computing device in accordance with the specifications in Subpart J of Part 15 of FCC Rules, which are designed to provide reasonable protection against such interference in a residential installation. However, there is no guarantee that interference will not occur in a particular installation. If this equipment does cause interference to radio or television reception, which can be determined by turning the equipment off and on, the user is encouraged to try to correct the interference by one or more of the following measures:

- If using an indoor antenna, have a quality outdoor antenna installed.
- Reorient the receiving antenna until interference is reduced or eliminated.
- Move the receiver away from the control/communicator.
- Move the antenna leads away from any wire runs to the control/communicator.
- Plug the control/communicator into a different outlet so that it and the receiver are on different branch circuits.

If necessary, the user should consult the dealer or an experienced radio/television technician for additional suggestions.

The user or installer may find the following booklet prepared by the Federal Communications Commission helpful:
"Interference Handbook"

This booklet is available from the U.S. Government Printing Office, Washington, DC 20402.
Stock No. 004-000-00450-7.

The user shall not make any changes or modifications to the equipment unless authorized by the Installation Instructions or User's Manual. Unauthorized changes or modifications could void the user's authority to operate the equipment.

IN THE EVENT OF TELEPHONE OPERATIONAL PROBLEMS

In the event of telephone operational problems, disconnect the control panel by removing the plug from the RJ31X (CA38A in Canada) wall jack. We recommend that you demonstrate disconnecting the phones on installation of the system. Do not disconnect the phone connection inside the Control Panel. Doing so will result in the loss of your phone lines. If the regular phone works correctly after the Control Panel has been disconnected from the phone lines, The Control Panel has a problem and should be returned for repair. If upon disconnection of the Control Panel, there is still a problem on the line, notify the telephone company that they have a problem and request prompt repair service. The user may not under any circumstances (in or out of warranty) attempt any service or repairs to the system. It must be returned to the factory or an authorized service agency for all repairs.

CANADIAN DEPARTMENT OF COMMUNICATIONS (DOC) STATEMENT

NOTICE

The Canadian Department of Communications label identifies certified equipment. This certification means that the equipment meets certain telecommunications network protective, operational and safety requirements. The Department does not guarantee the equipment will operate to the user's satisfaction.

Before installing this equipment, users should ensure that it is permissible to be connected to the facilities of the local telecommunications company. The equipment must also be installed using an acceptable method of connection. In some cases, the company's inside wiring associated with a single line individual service may be extended by means of certified connector assembly (telephone extension cord). The customer should be aware that compliance with the above conditions may not prevent degradation of service in some situations.

Repairs to certified equipment should be made by an authorized Canadian maintenance facility designated by the supplier. Any repairs or alterations made by the user to this equipment, or equipment malfunctions, may give the telecommunications company cause to request the user to disconnect the equipment.

Users should ensure for their own protection that the electrical ground connections of the power utility, telephone lines and internal metallic water pipe system, if present, are connected together. This precaution may be particularly important in rural areas.

Caution: User should not attempt to make such connections themselves, but should contact the appropriate electric inspection authority, or electrician, as appropriate.

The Load Number (LN) assigned to each terminal device denotes the percentage of the total load to be connected to a telephone loop which is used by the device, to prevent overloading. The termination on a loop may consist of any combination of devices subject only to the requirement that the total of the Load Numbers of all the devices does not exceed 100.

AVIS

L'étiquette du ministère des Communications du Canada identifie le matériel homologué. Cette étiquette certifie que le matériel est conforme à certaines normes de protection, d'exploitation et de sécurité des réseaux de télécommunications. Le ministère n'assure toutefois pas que le matériel fonctionnera à la satisfaction de l'utilisateur.

Avant d'installer ce matériel, l'utilisateur doit s'assurer qu'il est permis de le raccorder aux installations de l'entreprise locale de télécommunication. Le matériel doit également être installé en suivant une méthode acceptée de raccordement. Dans certains cas, les fils intérieurs de l'entreprise utilisés pour un service individuel à ligne unique peuvent être prolongés au moyen d'un dispositif homologué de raccordement (cordon prolongateur téléphonique interne). L'abonné ne doit pas oublier qu'il est possible que la conformité aux conditions énoncées ci-dessus n'empêchent pas la dégradation du service par certaines situations. Actuellement, les entreprises de télécommunication ne permettent pas que l'on raccorde leur matériel aux jacks d'abonnés, sauf dans les cas précis prévus par les tarifs particuliers de ces entreprises.

Les réparations de matériel homologué doivent être effectuées par un centre d'entretien canadien autorisé désigné par le fournisseur. La compagnie de télécommunications peut demander à l'utilisateur de débrancher un appareil à la suite de réparations ou de modifications effectuées par l'utilisateur ou à cause de mauvais fonctionnement.

Pour sa propre protection, l'utilisateur doit s'assurer que tous les fils de mise à la terre de la source d'énergie électrique, des lignes téléphoniques et des canalisations d'eau métalliques, s'il y en a, sont raccordés ensemble. Cette précaution est particulièrement importante dans les régions rurales.

Avertissement: L'utilisateur ne doit pas tenter de faire ces raccordements lui-même; il doit avoir recours à un service d'inspection des installations électriques, ou à un électricien, selon le cas.

L'indice de charge (IC) assigné à chaque dispositif terminal pour éviter toute surcharge indique le pourcentage de la charge totale qui peut être raccordée à un circuit téléphonique bouclé utilisé par ce dispositif. La terminaison du circuit bouclé peut être constituée de n'importe quelle combinaison de dispositifs, pourvu que la somme des indices de charge de l'ensemble des dispositifs ne dépasse pas 100.

WARNING

THE LIMITATIONS OF THIS ALARM SYSTEM

While this system is an advanced design security system, it does not offer guaranteed protection against burglary, fire or other emergency. An alarm system, whether commercial or residential, is subject to compromise or failure to warn for a number of reasons. For example:

- Intruders may gain access through unprotected openings or have the technical sophistication to bypass an alarm sensor or disconnect an alarm warning device.
- Intrusion detectors (e.g. passive infrared detectors), smoke detectors, and many other sensing devices will not work without power. Battery operated devices will not work without batteries, with dead batteries, or if the batteries are not put in properly. Devices powered solely by AC will not work if their AC power supply is cut off for any reason, however briefly.
- Signals sent by wireless transmitters may be blocked or reflected by metal before they reach the alarm receiver. Even if the signal path has been recently checked during a weekly test, blockage can occur if a metal object is moved into the path.
- A user may not be able to reach a panic or emergency button quickly enough.
- While smoke detectors have played a key role in reducing residential fire deaths in the United States, they may not activate or provide early warning for a variety of reasons in as many as 35% of all fires, according to data published by the Federal Emergency Management Agency. Some of the reasons smoke detectors used in conjunction with this System may not work are as follows. Smoke detectors may have been improperly installed and positioned. Smoke detectors may not sense fires that start where smoke cannot reach the detectors, such as in chimneys, in walls, or roofs, or on the other side of closed doors. Smoke detectors also may not sense a fire on another level of a residence or building. A second floor detector, for example, may not sense a first floor or basement fire. Moreover, smoke detectors have sensing limitations. No smoke detector can sense every kind of fire every time. In general, detectors may not always warn about fires caused by carelessness and safety hazards like smoking in bed, violent explosions, escaping gas, improper storage or flammable materials, overloaded electrical circuits, children playing with matches, or arson. Depending on the nature of the fire and/or the location of the smoke detectors, the detector, even if it operates as anticipated, may not provide sufficient warning to allow all occupants to escape in time to prevent injury or death.
- Passive Infrared Motion Detectors can only detect intrusion within the designed ranges as diagrammed in their installation manual. Passive Infrared Detectors do not provide volumetric area protection. They do create multiple beams of protection, and intrusion can only be detected in unobstructed areas covered by the beams. They cannot detect motion or intrusion that takes place behind walls, ceilings, floors, closed doors, glass partitions, glass doors, or windows. Mechanical tampering, masking, painting or spraying of any material on the mirrors, windows or any part of the optical system can reduce their detection ability. Passive Infrared Detectors sense changes in temperature; however, as the ambient temperature of the protected area approaches the temperature range of 90° to 150°F, the detection performance can decrease.
- Alarm warning devices such as sirens, bells or horns may not alert people or wake up sleepers who are located on the other side of a closed or partly open doors. If warning device sound on a different level of the residence from the bedrooms, then they are less likely to waken or alert people inside the bedrooms. Even persons who are awake may not hear the warning if the alarm is muffled by noise from a stereo, air conditioner or other appliances, or by passing traffic. Finally, alarm warning devices, however loud, may not warn hearing-impaired people or waken deep sleepers.

Telephone lines needed to transmit alarm signals from a premises to a central monitoring station may be out of service or temporarily out of service. Telephone lines are also subject to compromise by sophisticated intruders.

• Even if the system responds to the emergency as intended, however, occupants may have insufficient time to protect themselves from the emergency situation. In the case of a monitored alarm system, authorities may not respond appropriately.

• This equipment, like other electrical devices, is subject to component failure. Even though this equipment is designed to last as long as 10 years, the electronic components could fail at any time.

The most common cause of an alarm system not functioning when an intrusion or fire occurs is inadequate maintenance. This alarm system should be tested weekly to make sure all sensors are working properly.

Installing an alarm system may make one eligible for lower insurance rates, but an alarm system is not a substitute for insurance. Homeowners, property owners and renters should continue to act prudently in protecting themselves and continue to insure their lives and property.

We continue to develop new and improved protection devices. Users of alarm systems owe it to themselves and their loved ones to learn about these developments.

ADEMCO LIMITED WARRANTY

Alarm Device Manufacturing Company, a Division of Pittway Corporation, and its divisions, subsidiaries and affiliates ("Seller"), 165 Eileen Way, Syosset, New York 11791, warrants its products to be in conformance with its own plans and specifications and to be free from defects in materials and workmanship under normal use and service for 18 months from the date stamp control on the product or, for products not having an Ademco date stamp, for 12 months from date of original purchase unless the installation instructions or catalog sets forth a shorter period, in which case the shorter period shall apply. Seller's obligation shall be limited to repairing or replacing, at its option, free of charge for materials or labor, any product which is proved not in compliance with Seller's specifications or proves defective in materials or workmanship under normal use and service. Seller shall have no obligation under this Limited Warranty or otherwise if the product is altered or improperly repaired or serviced by anyone other than Ademco factory service. For warranty service, return product transportation prepaid, to Ademco Factory Service, 165 Eileen Way, Syosset, New York 11791.

THERE ARE NO WARRANTIES, EXPRESS OR IMPLIED, OF MERCHANTABILITY, OR FITNESS FOR A PARTICULAR PURPOSE OR OTHERWISE, WHICH EXTEND BEYOND THE DESCRIPTION ON THE FACE HEREOF. IN NO CASE SHALL SELLER BE LIABLE TO ANYONE FOR ANY CONSEQUENTIAL OR INCIDENTAL DAMAGES FOR BREACH OF THIS OR ANY OTHER WARRANTY, EXPRESS OR IMPLIED, OR UPON ANY OTHER BASIS OF LIABILITY WHATSOEVER, EVEN IF THE LOSS OR DAMAGE IS CAUSED BY THE SELLER'S OWN NEGLIGENCE OR FAULT.

Seller does not represent that the products it sells may not be compromised or circumvented; that the products will prevent any personal injury or property loss by burglary, robbery, fire or otherwise; or that the products will in all cases provide adequate warning or protection. Customer understands that a properly installed and maintained alarm may only reduce the risk of a burglary, robbery, fire or other events occurring without providing an alarm, but it is not insurance or a guarantee that such will not occur or that there will be no personal injury or property loss as a result. CONSEQUENTLY, SELLER SHALL HAVE NO LIABILITY FOR ANY PERSONAL INJURY, PROPERTY DAMAGE OR OTHER LOSS BASED ON A CLAIM THE PRODUCT FAILED TO GIVE WARNING. HOWEVER, IF SELLER IS HELD LIABLE, WHETHER DIRECTLY OR INDIRECTLY, FOR ANY LOSS OR DAMAGE ARISING UNDER THIS LIMITED WARRANTY OR OTHERWISE, REGARDLESS OF CAUSE OR ORIGIN, SELLER'S MAXIMUM LIABILITY SHALL NOT IN ANY CASE EXCEED THE PURCHASE PRICE OF THE PRODUCT, WHICH SHALL BE THE COMPLETE AND EXCLUSIVE REMEDY AGAINST SELLER. This warranty replaces any previous warranties and is the only warranty made by Seller on this product. No increase or alteration, written or verbal, of the obligations of this Limited Warranty is authorized.



N5944 V2 2/82

ALARM DEVICE MANUFACTURING CO.
A DIVISION OF PITTWAY CORPORATION
165 Eileen Way, Syosset, New York 11791

Copyright © 1981 PITTWAY CORPORATION